



⌋ Automated Sign Production ⌋

User's Manual
Rev 003

FCC Notice

The DC4sx have been tested and found to comply with the limits for Class A digital devices, pursuant to Part 15 of the FCC Rules. These limits are designed to provide reasonable protection against harmful interference when the equipment is operated in a commercial environment. The cutters generate, use and can emit radio frequency energy and, if not installed and used in accordance with the instruction manual, may cause harmful interference to radio communications. Operation of the cutters in a residential area is likely to cause harmful interference, in which case the user will be required to correct the interference at his own expense.

Caution!

Changes or modifications not expressly approved by Summa, which is responsible for FCC compliance, could void the user's authority to operate this equipment.

DOC Notice

The DC4sx do not exceed the Class A limits for radio noise for digital apparatus set out in the Radio Interference Regulations of the Canadian Department of Communications.

Notice

Summa reserves the right to modify the information contained in this User Manual at any time without prior notice. Unauthorized copying, modification, distribution or display is prohibited. All rights reserved.

Waste Electrical and Electronic Equipment (WEEE) Directive

Directive 2002/96/EC of the European Parliament and of the Council

The symbol (right) is shown on this product. It indicates that the product should not be disposed of with regular household waste, but should be disposed of separately.

Electrical and electronic equipment can contain materials that are hazardous to the environment and human health and therefore should be disposed of at a designated waste facility or returned to your retailer for the appropriate recycling to take place.



If you wish to dispose of this product and the product still functions, please consider recycling/reusing it by donating it to a charity shop, selling it or part-exchanging it with your retailer.

Registering Your Printer

Please register your printer on the following link:

<http://www.summa.be/registration.html>

Failure to register may result in delayed responses to your warranty and service inquiries.

Contact Information

All inquiries, comments or suggestions concerning this and other Summa manuals should be directed to:

<i>North America and Asia Pacific</i>	<i>Eastern United States and Latin America</i>	<i>Europe, Africa and Middle East</i>
Summa, Inc 10001 Lake City Way NE Seattle, WA 98125 USA	Summa East, Inc 222 Jubilee Drive Peabody, MA 01960 USA	Summa, bvba Rochesterlaan 6 B-8470 GISTEL Belgium
Main Office +1-206-527-1050 +1-800-527-7778	Main Office +1-978-531-1991 +1-888-527-1050	Main Office +32 (0)59 270011
Fax +1-206-527-1046	Fax +1-978-531-1993	Fax +32 (0)59 270063
Support support@summausa.com	Support support@summausa.com	Support support@summa.be
Sales sales@summa.us	Sales sales@summa.us	Sales sales@summa.be
Web Site www.summausa.com	Web Site www.summausa.com	Web Site www.summa.be



Welcome

Congratulations on your purchase of the new DC4sx!

The DC4sx is the ultimate label and decal production unit, combining high image durability and precision contour cutting into one device.

The DC4sx uses thermal transfer technology. This is a dry transfer printing process that uses heat and pressure to create a durable bond with the resin-based inks and the media. The resin inks are supplied on ribbons containing densely packed pigments suspended in a solid plastic carrier. This high pigment density results in images that are highly abrasion resistant, and it provides a long term UV and water resistance with a long outdoor durability without laminations.

Thermal transfer printing produces no fumes at all, creates no mess and does not require maintenance or the use of cleaning chemicals.





Every aspect of the DC4sx has been designed for simplified operation. Media loading is child's play, thanks to auto media alignment. Ribbons are a snap to refill, and can't be loaded improperly.

This manual is a reference guide for installing and operating the DC4sx.



Table of Contents

1	Setup	1-1
1.1	Unpacking the DC4sx	1-1
1.2	DC4sx printer components	1-4
1.2.1	The DC4sx as viewed from the front	1-4
1.2.2	The printer as viewed from the back	1-5
1.3	Ideal Operating Environment	1-6
1.4	Connecting the Printer to the Mains	1-7
1.4.1	Grounding (“Earthing”)	1-7
1.4.2	Operating voltage	1-7
1.4.3	Powering-on the printer	1-8
1.5	Connecting the DC4sx to a Computer	1-9
1.5.1	Connecting the printer to a PC using a USB cable	1-9
1.5.2	Connecting the printer to a Mac using a USB cable	1-10
1.6	Media Handling	1-11
1.6.1	Loading media	1-11
1.6.2	Using media take-up rollers (optional)	1-13
1.6.3	Unloading the media	1-14
1.6.4	Using the media basket	1-14
1.7	Loading ribbon cassettes	1-15
1.7.1	Loading and removing the cassettes	1-15
1.7.2	Refilling ribbon cassettes	1-16
1.8	Knife Installation	1-18
1.8.1	Removing the drag knife	1-18
1.8.2	Installing the drag knife	1-19

2	Basic Operation	2-1
2.1	The control Panel	2-1
2.1.1	The liquid crystal display	2-1
2.1.2	The  and  key	2-2
2.1.3	The  key	2-2
2.1.4	The  key	2-2
2.1.5	The arrow  Keys.....	2-2
2.2	How to Set printing Density	2-3
2.3	How to Set Media Tracking Parameters	2-4
2.4	How to set the main knife parameters:	2-7
2.5	How to calibrate print and Cut	2-9
2.6	How to Change the User (Quick Parameter Change)	2-10
2.7	How to Change media width	2-11
2.7.1	Placing of the pinch roller	2-11
2.7.2	Using non recommended media widths.	2-11
2.8	Preparing the DC4sx for long print-outs	2-12
3	Print & Cut	3-1
3.1	Contour cutting	3-1
3.1.1	Making the design	3-1
3.1.1.1	Contour cutting	3-2
3.1.1.2	<i>OPOS cutting</i>	3-2
3.1.1.3	Making cutting data ready	3-5
3.2	Cutting trough	3-6

4	Detailed Operation	4-1
4.1	Introduction.....	4-1
4.2	Main menu.....	4-2
4.2.1	Printer menu	4-2
4.2.2	Reprint job	4-2
4.2.3	Cutter menu.....	4-2
4.2.4	System setup.....	4-2
4.2.5	Select User Configuration.....	4-2
4.2.6	Shut down.....	4-2
4.2.7	Reset	4-2
4.3	Printer menu	4-3
4.3.1	Ribbon status.....	4-3
4.3.2	Density.....	4-3
4.3.3	Print Speed.....	4-3
4.3.4	Double Density	4-3
4.3.5	Dot overlap	4-3
4.3.6	Color Offset	4-4
4.3.7	ScratchGuard	4-4
4.3.8	OptiTrac™ Color.....	4-4
4.3.9	OptiTrac™	4-4
4.3.10	Calibrate linefeed.....	4-5
4.3.11	Calibrate Print&Cut.....	4-5
4.3.12	Head alignment test.....	4-5
4.3.13	Clean printhead	4-5
4.4	Cutter menu	4-6
4.4.1	Knife pressure	4-6
4.4.2	Knife offset.....	4-6
4.4.3	Velocity	4-6
4.4.4	Overcut	4-6
4.4.5	DIN test.....	4-7
4.4.6	Load OPOS Markers	4-7
4.4.7	Flex mode.....	4-7
4.5	Setup menu	4-8
4.5.1	Take-up roll.....	4-8
4.5.2	Ribbon Save	4-8
4.5.3	Calibrate media	4-8
4.5.4	Calibrate Print&Cut.....	4-8
4.5.5	Calibrate OPOS.....	4-9
4.5.6	Cal. Temp. Sensors.....	4-9
4.5.7	Firmware revision	4-9
4.5.8	Room temperature.....	4-9
4.5.9	Coil setup.....	4-9
4.5.10	Show printer usage.....	4-9
4.5.11	Show job stats	4-10
4.5.12	Copy User Config.	4-10
4.5.13	Print Demo File.....	4-10

5	Maintenance and Cleaning	5-1
5.1	GENERAL INFORMATION.....	5-1
5.1.1	Cleaning the drive system	5-1
5.1.2	Cleaning the media sensors	5-2
5.1.3	Cleaning the cleaning pad	5-3
5.1.4	Cleaning the printhead	5-4
5.1.5	OptiPrint™ cleaning system	5-4
5.1.6	Cleaning the printing surface	5-5
5.1.7	Cleaning the OptiTrac™ sensor	5-5
5.2	OPERATING VOLTAGE.....	5-6
6	Software for the PC	6-1
6.1	Introduction.....	6-1
6.1.1	Installing Summa Color Control	6-2
6.1.2	Installing WinPlot	6-3
6.1.3	Installing printer tools.....	6-3
6.2	Summa Printer Control Menus.....	6-5
6.2.1	File menu	6-5
6.2.2	View menu	6-5
6.2.3	Configuration menu	6-6
6.2.4	Settings menu.....	6-6
6.2.5	Tests menu.....	6-6
6.2.6	Action list	6-7
6.2.7	Configuration settings.....	6-7
6.2.8	Tool properties.....	6-7
6.2.9	Info.....	6-8
6.2.10	Users	6-8
6.2.11	Tool bars.....	6-9
6.3	Summa Color Control (SCC) configuration	6-10
6.3.1	ColorControl Preferences	6-10
6.3.2	Process preferences.....	6-11
6.3.3	RIP preferences.....	6-12
6.3.4	DC4sx preferences	6-13
6.3.5	Reprint preferences	6-14
6.3.6	How to rip and print	6-15
6.3.7	General tab.....	6-15
6.3.8	Color Tab.....	6-16
6.3.9	Screening tab	6-17
6.3.10	Layout tab.....	6-20
6.3.11	Advanced tab.....	6-21
6.3.12	How to rip,View and print.....	6-23
7	Specifications	7-1
7.1	Features List	7-1
7.1.1	Hardware	7-1
7.1.2	Interface.....	7-1
7.1.3	Functionality	7-1
7.1.4	Software	7-2

List of Figures

1-1 DC4sx on shipping pallet	1-1
1-2 Unpacking DC4sx stage 2	1-2
1-3 Unpacking DC4sx stage 3	1-2
1-4 Unpacking DC4sx final stage 4	1-3
1-5 DC4sx, front view	1-4
1-6 DC4sx, rear view	1-5
1-7 Properly grounded connection	1-7
1-8 Media is loaded and ready	1-8
1-9 DC4sx is on and no media is loaded	1-8
1-10 Media Core holder	1-11
1-11 Position of the supply roll on the DC4sx	1-11
1-12 Loading roll at the back of DC4sx	1-12
1-13 Loading roll at the front of the DC4sx	1-12
1-14 Rear basket	1-14
1-15 Rear cassette station cover	1-15
1-16 Removing a Cassette	1-15
1-17 Loading a cassette	1-15
1-18 Cassette top release tabs	1-16
1-19 Loading ribbon and ribbon information chip into the cassette	1-16
1-20 Closing the ribbon cassette	1-17
1-21 Removing the drag knife holder from the clamp	1-18
1-22 Removing the knife from the standard drag knife holder	1-18
1-23 Knife length adjustment	1-19
1-24 clamp drag head	1-19
2-1 DC4sx Control Panel	2-1
2-2 Internal Density Test	2-3
2-3 recommended line feed calibration test	2-5
2-4 simple line feed calibration test	2-5
2-5 Automatic head alignment test	2-6
2-6 Knife depth test pattern	2-7
2-7 Correct knife offset pattern	2-8
2-8 CPrint and cut test pattern	2-9
2-9 Repositioning roller guide	2-12
3-1 Design with contour	3-1
3-2 advised places for contour placement	3-2
3-3 Placement of the first (origin) marker	3-2
3-4 Placement of the rest of the markers	3-3
3-5 Printed design	3-4
3-6 selecting cut data	3-5
4-1 complete menu structure	4-1
4-2 Store status	4-3
4-3 Color offset	4-4
4-4 Head alignment test	4-5
4-5 calibrate media test	4-8
5-1 Cleaning the drive sleeves	5-2
5-2 position of the front and rear media sensor	5-2
5-3 Cleaning pad	5-3
5-4 Cleaning the printhead	5-4
5-5 Cleaning OPOS sensor	5-5
5-6 power entry module	5-6

6-1 installation of software	6-1
6-2 Language selection of SCC	6-2
6-3 HASP driver installation	6-2
6-4 installation of Printer Tools.....	6-4
6-5 installation of separate printer tools	6-4
6-6 Summa Printer Control start screen.....	6-5
6-7 configuration settings.....	6-7
6-8 Tool properties	6-7
6-9 info	6-8
6-10 User configurations.....	6-8
6-11 ColorControl preferences.....	6-10
6-12 Process preferences	6-11
6-13 RIP preferences	6-12
6-14 preferences	6-13
6-15 Reprint preferences	6-14
6-16 General tab	6-15
6-17 Color Tab	6-16
6-18 Screening tab.....	6-17
6-19 difference between line frequencies	6-17
6-20 Screen angles	6-18
6-21 Layout tab	6-20
6-22 Advanced tab	6-21
6-21 Masking.....	6-22
6-22 Primer dot	6-22
6-23 Vision print	6-23

1.1 Unpacking the DC4sx

NOTE: Save the shipping box and any other packaging items in case the printer needs to be moved. Do not transport the printer without first completely repacking it in its original packaging.

CAUTION: For safety reasons, no fewer than two people should be involved in unpacking the printer.

Before unpacking, make sure to have at least 4 meter of space at one side of the box, because the printer will be rolled down a ramp

Remove the straps and open the flaps of the box, take out the 4 foam blocks. Then remove the box from the pallet; this must be done in a room that is at least 2.5 meter high.

Remove the protective bag then cut all the straps and cable ties. Next, set aside the accessories box.



FIG 1-1
DC4SX ON SHIPPING PALLET

The printer is secured to the base at each side with a bracket.

Remove the 4 nuts (# 17 mm) located at each side. Next, lift the brackets up and out by pulling the bottom part backwards under the DC4sx, and then remove them.

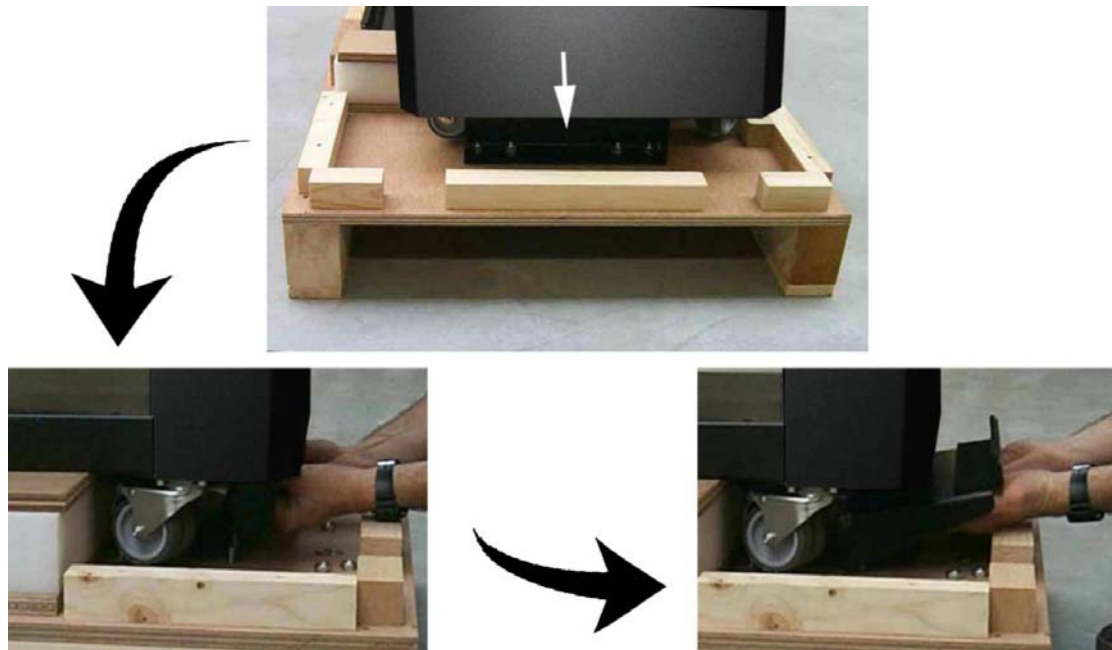

FIG 1-2
UNPACKING DC4SX STAGE 2

Remove the two foam blocks from underneath the stand. Do this using the two ramps, which are screwed to the pallet. Slide the ramp under the stand, closest to the end with the foam suspension blocks.

From this point on, two people ARE REQUIRED for safety reasons.

Lift the DC4sx from each side, just high enough so the foam blocks can be pulled out from underneath the DC4sx.

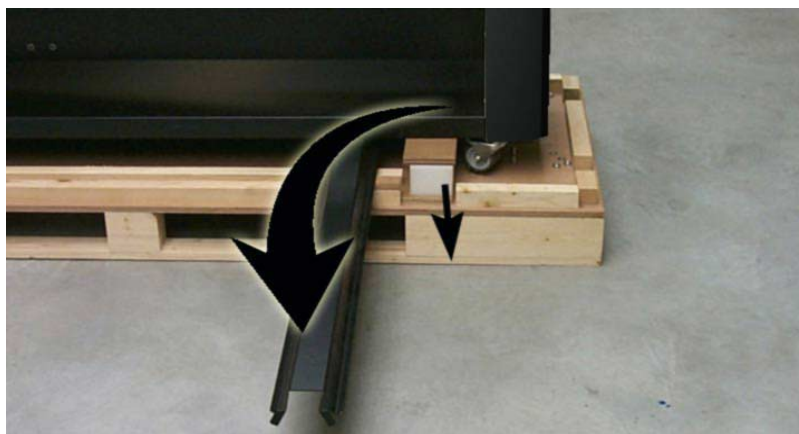

FIG 1-3
UNPACKING DC4SX STAGE 3

Position the ramps so the printer can be rolled down from the pallet. Be sure the wheels of the printer are aligned with the ramp legs.

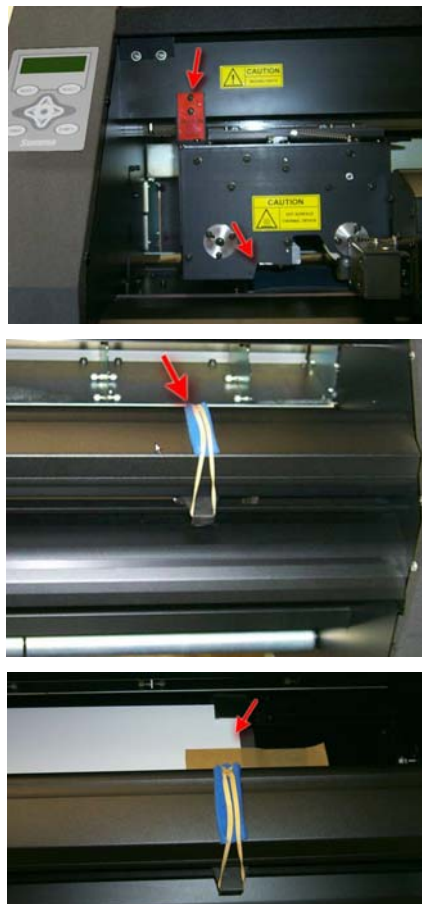

FIG 1-4
UNPACKING DC4SX FINAL STAGE 4

Open the front cover and loosen the printer carriage, then remove the foam underneath the carriage, which is protecting the printhead.

Loosen the cutter carriage.

Remove the protective sheet from the printing surface. The printing surface is very fragile, please read section 5.1.6.



1.2 DC4sx printer components

1.2.1 The DC4sx as viewed from the front

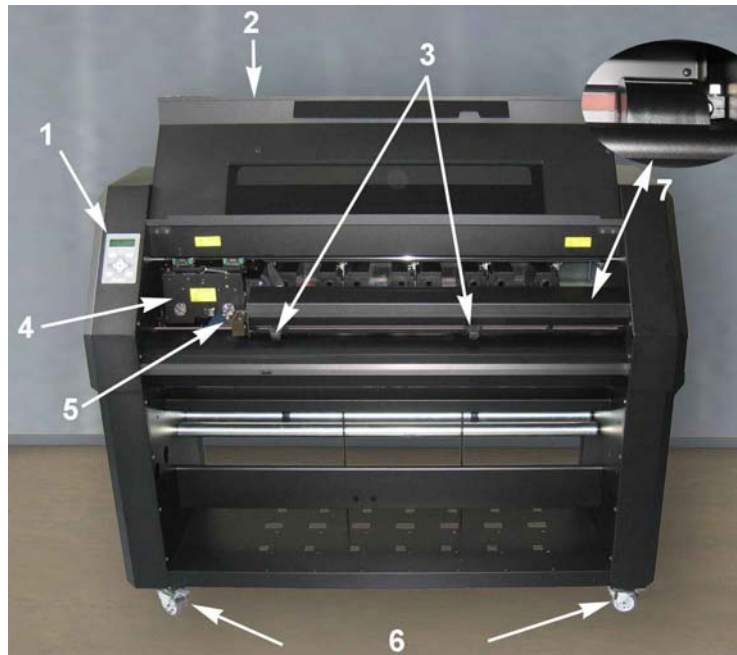

FIG 1-5
DC4SX, FRONT VIEW

1. **Control Panel and LCD:** All printer activity can be initiated from the 8 key control panel. The LCD informs the user on the current status of the printer, or actions, which need to be taken. A detailed explanation can be found in section 4.
2. **Front Cover:** The front cover protects the media from dust and also the operator from any moving parts during operation. Therefore, the front cover must be kept closed during operation. To open the front cover, you must first pause the machine.
3. **Pinch Rollers:** The pinch rollers clamp the media to the drive system and insure necessary tracking. The pinch rollers are electrically powered from the keypad. The right pinch roller can be set in 2 different positions.
4. **Printer Carriage:** The printer carriage holds the ribbon cassette and the thermal printhead. The thermal printhead is made from fragile ceramic glaze; **DO NOT TOUCH THE PRINTHEAD** as oil or moisture can corrode the surface. The printhead can also be **VERY HOT**, just after printing.
5. **Cleaning Plate:** The cleaning plate is used to clean the thermal printhead. While printing, the printhead cleans itself automatically and at regular intervals.
6. **Front Wheels:** The front wheels of the DC4sx are equipped with locking brakes. Secure the brakes, once the DC4sx is permanently installed, by pressing the locking wheel brake down with your foot.
7. **Cutter Carriage:** The cutter carriage is the mount for the contour cutting knife holder.

1.2.2 The printer as viewed from the back

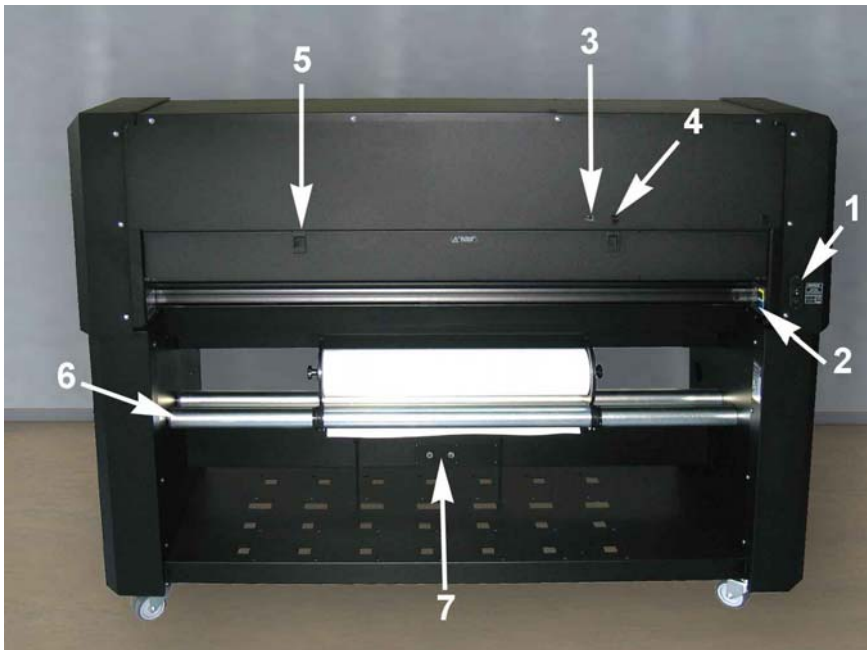

FIG 1-6
DC4SX, REAR VIEW

1. **Power Entry Module:** The fuse box, the AC power cord receptacle and the on/off switch are located in the power entry module. See section 1.4.3. for power up procedure and section 1.4.3. for information about changing the fuse.

CAUTION: For continued protection against risk of fire, replace only with the same type and rating of fuse.

2. **Media Load push buttons:** On the right side there are two push buttons, conveniently located to make the loading process easy. For further explanation, see section 1.6.1.
3. **USB port:** This interface is based on the standards specified in Universal Serial Bus Specifications Revision 1.1. It allows for high-speed bi-directional serial communication between the host computer and the DC4sx.
4. **Cable clamp:** These two cable clamps provide a neat path for the communication cables.
5. **Cassette station latch:** Two latches are located at the back, in order to open up the cassette station. Open only when the machine is paused or switched off.
6. **Media supply rollers:** The two back rollers are part of the media supply system.
7. **Media Supply Sensor:** The media supply sensor enables the motorized media supply rollers. - Do not place any objects in front of the sensor.

1.3 Ideal Operating Environment

Environmental conditions can significantly affect the printer's performance. High humidity, high temperatures, direct sunlight and airborne contamination (dust) can adversely affect print quality. The printer should be located away from windows and doors, preferably within a clean interior room of a building.

Check for the following conditions when installing the DC4sx:

- Surface must be level without vibration
- Operating temperature should be stable, between 18 - 27 degrees Celsius (65 to 80 degrees Fahrenheit).
- Operating humidity should be stable, between 30% and 75%.
- Area should not be prone to static electricity (no carpeted floors).
- Be sure to allow enough space surrounding the printer for changing media rolls and ribbons. At least 500mm (24 inches) on both sides, and 1000mm (40 inches) behind and in front of the printer.
- The printer uses a universal power supply that can operate from 100 to 240 volts with a line frequency of 50 or 60 Hz.

1.4 Connecting the Printer to the Mains

1.4.1 Grounding ("Earthing")

CAUTION: An insulated ground conductor must be installed as part of the branch circuit that supplies power to the wall outlet to which the printer is connected. The ground conductor must have the same size, insulation material and thickness as the grounded and ungrounded branch circuit supply conductors, but the insulating seat should be green or green with yellow striping.

The ground conductor described above must be grounded at the electrical distribution board or, if power is supplied by a separate system, at the power supply transformer/motor generator set.

The wall sockets into which the printer is plugged must be of the grounded type. The grounded conductors serving the wall socket must be properly connected to the ground.

For emergency access, the printer should be installed near the socket-outlet for easy access.

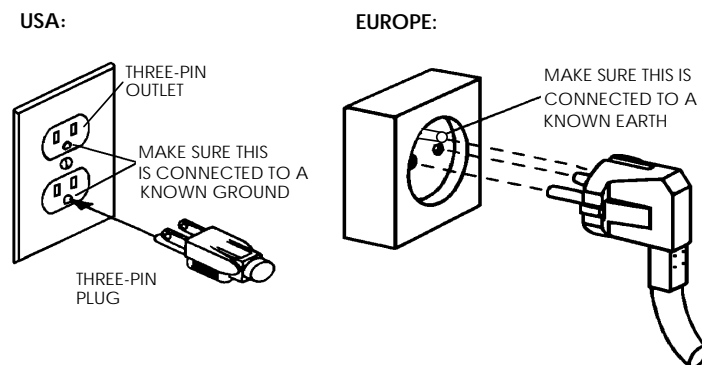

FIG 1-7
PROPERLY GROUNDED CONNECTION

1.4.2 Operating voltage

CAUTION: Before changing the fuse, make sure that the printer is completely disconnected from its power source.

CAUTION: For continued protection against risk of fire, replace only with the same type and rating of fuse.

Fuse Rate: T4.0A, 250V SCHURTER SPT OR EQUIVALENT.

The power supply detects the line voltage and switches automatically between 110V and 230V.

1.4.3 Powering-on the printer

CAUTION: Be sure the power switch is turned off before connecting the power cord (the "0" side of the ON/OFF rocker switch should be pressed).

WARNING
KEEP FINGERS AND OTHER BODY PARTS AWAY FROM THE CUTTING
AREA. THERE ARE HAZARDOUS MOVING PARTS.

Plug the female end of the AC power cord into the receptacle located in the power entry module on the printer's rear panel.

Plug male end of the AC power cord into a properly grounded wall socket.

Power on the printer by pressing the "1" side of the ON/OFF rocker switch located on the power entry module on the rear panel.

The LCD display will activate and an initializing process will begin. Depending on whether there is media loaded or not, the process will be different. When there is no media loaded, the DC4sx will prompt the user for a media load procedure. When media is loaded, the DC4sx will measure the media width and check the presence of the cassettes and estimate how much usable ribbon is remaining on the roll. After loading a small letter will appear on the top row second last digit of the LCD. S for small and L for large. The letters indicate for which media width the line calibration (see section 2.3) was done.

```
SUMMA DC4sx      L
PRINT WIDTH: 581mm
PREMIUM WHITE VINYL
[MENU]           [PAUSE]
```

FIG 1-8
 MEDIA IS LOADED AND READY

```
SUMMA DC4sx      L
INSERT MEDIA
[MENU]           [PAUSE]
```

FIG 1-9
 DC4SX IS ON AND NO MEDIA IS LOADED

1.5 Connecting the DC4sx to a Computer

The DC4sx support bi-directional USB.

The USB cable should be 5 meters (16 feet) or less in length. The connector on the printer side of the cable should be USB series B 4-pin. The connector on the computer side of the cable should be USB A 4-pin.

1.5.1 Connecting the printer to a PC using a USB cable:

1. Power off the DC4sx.
2. Insert the DC4sx CD into the computer's CD-ROM drive.
3. Connect one end of the USB cable to a USB port on the computer.
4. Connect the other end of the USB cable to the USB port on the back of the printer.
5. Power on the printer (see section 1.4.3) and return to the computer.

The Found New Hardware Wizard should appear on the computer screen and ask for the USB driver.

6. Click "OK" and follow the instructions provided by the Wizard.

Windows will find and install the driver.

7. Remove the CD from the CD-ROM drive.
8. Restart the computer.

NOTE: When the DC4sx is connected to a computer for the first time using the USB cable, the computer will detect the printer and ask for the USB driver. The driver is included on the CD containing this user's manual. Failure to install the USB driver the first time the printer is connected may result in the computer listing it as an "unknown device." Then the only way to install the driver properly is to uninstall the device or to update the driver using the Windows device manager.

1.5.2 Connecting the printer to a Mac using a USB cable

- Mac OS 8.5 to OS 9.2

1. Power off the printer.
2. Connect one end of the USB cable to a USB port on the computer.
3. Connect the other end of the USB cable to the USB port on the back of the printer.
4. Power on the printer (see section 1.4.3) and return to the computer.
5. Insert the DC4sx CD into the computer's CD-ROM drive.
6. Click on the "USB install driver" icon on the CD-ROM.

This will automatically install the driver and the Summa Port Mapper utility.

7. Remove the CD from the CD-ROM drive.
8. Restart the computer.

NOTE: If the printer is connected to the computer before device installation, then the computer will regard the printer as an unknown device. The driver can be installed at any time with or without the printer connected.

- Mac Osx

Most recent print/cut software does not need a driver installation when a computer is connected to the printer. The software that controls the driver is built into the software.

1.6 Media Handling

1.6.1 Loading media

The DC4sx is designed to work with rolls of media, not sheets.

It is advised to use cotton gloves while loading the media, otherwise the surface of the media becomes contaminated by oil from fingers, and the beginning of the printout will be unusable.

Two media core end holders are delivered with the machine. The printer aligns the media automatically during operation. Therefore, the left side of the vinyl roll must be straight (seen from the front of the DC4sx).

To load the media proceed as follows:

While loading the media, do not touch the gray printing surface (platen)! Doing so might permanently damage the delicate printing surface.

1. Switch the printer on.
2. Insert a media core holder in each end of the media roll. Check first if they are loosened. If not, loosen them with the black knob at the side. Figure 1-10 shows a loosened (1) core holder and an expanded (2) core holder.



FIG 1-10
MEDIA CORE HOLDER

3. Insert the loosened core holders into each end of the roll. Then tighten them with the black knob, be sure both core holders are secured.
4. Place the media roll on the DC4sx rollers. The right core holder guide is at a fixed position on the supply rollers bar. The left guide is adjustable. Make sure the media roll is positioned as in figure 1-8. Guide the beginning of the vinyl around the second supply roll (1). Then make a big loop underneath and behind the two roller bars, and pull it upwards and into the machine.





FIG 1-11
POSITION OF THE SUPPLY ROLL ON THE DC4SX

5. Press the bottom pushbutton (1), located on the right side, to unwind the media roll. Hold the media so it does not touch the floor. Insert the vinyl between the cassette station and the base. Make sure it is loaded far enough so that the beginning of the vinyl is underneath the clamp. Press pushbutton again.

The clamp will come down and hold the vinyl.



FIG 1-12
LOADING ROLL AT THE BACK OF DC4SX

6. Next, return to the front of the machine. Hold the vinyl and push .
7. Align the edge of the media using the alignment markers (1), on the front of the base, then push .

Just before the DC4sx starts to print, it will test the media alignment and the position, relative to the origin, before it starts printing. If the media is too far from the origin, then the DC4sx will “Park” the media on the starting point (origin). If it is not loaded straight, it will align it automatically (unless OptiTrac is set to ‘white background’).



FIG 1-13
LOADING ROLL AT THE FRONT OF THE DC4SX

The pinch rollers will now come down and the media is properly loaded. The machine will remain paused until the front cover is closed. After closing the front cover, the DC4sx will measure the media width. If the media width has changed, then the printer will prompt the user to check if the right pinch roller is set correct.

1.6.2 Using media take-up rollers (optional)

The DC4sx can be equipped with an automatic (motorized) roll take-up system. The take-up rollers are only active if the DC4sx is printing.

If a printed image is to be contour cut, the take-up rollers **MUST** be disabled.

To use the take-up rollers, follow procedure below:

Using an empty media core, insert media core holders into each end and attach a piece of scrap vinyl to the core with adhesive tape (minimum 1 meter long). Place this core and vinyl on the DC4sx as shown in the picture.



PREPARING TAKE-UP ROLL

Attach the scrap media to the edge of the vinyl. Allow for some slack so the DC4sx can align and park the media if necessary. If the take-up rollers are enabled, and if the DC4sx is printing, then the media will be rolled up.



USING THE TAKE-UP ROLL

1.6.3 Unloading the media.

First, detach the media from the take-up roll (if used).

Then push on the ▲ (up arrow) key until the media does not move any further.

Go to the back of the machine and press on the top switch. The machine will rewind the media supply roll and move the media from under the clamps. Keep the switch press

Each time the media type is changed, the user must perform the recommended line feed calibration (see section 2.3). Failing to do so may result in poor print quality.

1.6.4 Using the media basket

It is strongly recommended to always use the rear basket while printing. The basket prevents the vinyl from touching the ground or the base of the DC4sx, thus preventing the vinyl from collecting dust.

When the DC4sx is used for print and cut, then the media baskets, front and rear, **MUST** be used, otherwise the vinyl will pick up dust, damaging the print.

The front and rear baskets are designed to hold at least 6 meter of vinyl. Depending on the type of vinyl, it is possible to hold up until 10 meters.



FIG 1-14
REAR BASKET

1.7 Loading ribbon cassettes

1.7.1 Loading and removing the cassettes

The DC4sx can take up to 5 cassettes. The cassettes can be loaded or removed from the cassette station at any time, even during printing. If the printer is missing a color, then it will give a message on the LCD just before it needs the color. The machine automatically detects the end of a ribbon. If the machine runs out of a certain ribbon color while printing, then it will pause until the operator inserts a new ribbon. As soon as the machine detects a new ribbon roll, it will continue to print and complete the image.

ALWAYS load or remove cassettes from behind the printer. To remove a cassette, open the rear cover by pulling down both latches simultaneously.



FIG 1-15
REAR CASSETTE STATION COVER

To remove a cassette, lift it enough to pass over the rubber bumper, then pull it backwards and out of the printer.

To load a cassette, push it gently into an open location, until it just passes the rear bumper, then press it down and pull it backwards against the bumper.



FIG 1-16
REMOVING A CASSETTE



FIG 1-17
LOADING A CASSETTE

Close the rear cover. After the media is loaded, DC4sx will take the cassette and estimate the amount of ribbon in the cassette available for printing.

The printer will not check the cassettes if no media is loaded

! CAUTION !

Do not insert empty cassettes, without ribbon.

1.7.2 Refilling ribbon cassettes

The DC4sx prints by transferring pigmented vinyl resin directly onto vinyl media. Each color is printed separately in strips (app. 10cm wide), printing yellow first, then magenta, cyan and sometimes black. The media is then advanced (feed) an exact distance in order to print the next strip (band), carefully aligning each pixel.

The ribbons are wound onto plastic cores, which are unique to the DC4sx cassette and printer carriage. First, remove the protective ribbon wrapping and place the RI (ribbon identification) chip aside. This ribbon chip contains information about the ribbon's color formulation and transfer energy, necessary for printing. The RI chips are color-coded for easy identification.

1. Open the cassette by pressing the release tabs on each side (1), and then lifting upward the top hinges, in the back, to the bottom part.



FIG 1-18
CASSETTE TOP RELEASE TABS

2. Insert the RI chip into the bottom of the cassette (orientation is shown in figure 1-20 – the arrow indicates the direction for inserting).
3. Place the ribbon into the cassette, as shown below. There is also a small diagram inside the cassette bottom, to help remind the loading direction.

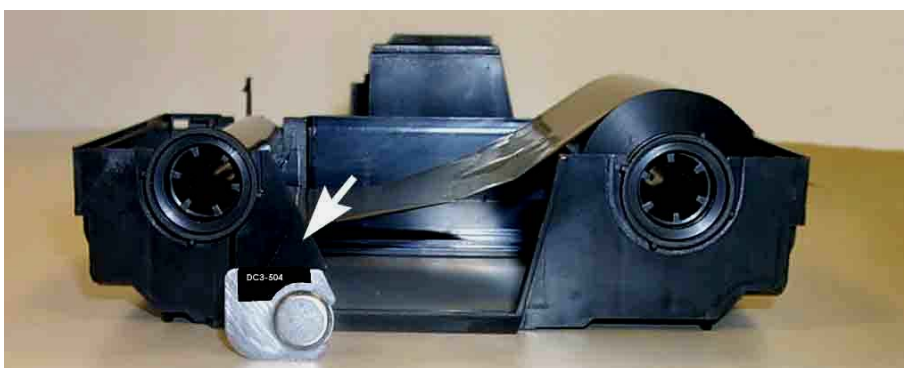

FIG 1-19
LOADING RIBBON AND RIBBON INFORMATION CHIP INTO THE CASSETTE

4. When closing the cassette, make sure the hinge pins (top piece) fit securely into the notched out bottom part of the cassette (2).



FIG 1-20
CLOSING THE RIBBON CASSETTE

1.8 Knife Installation

SAFETY WARNING: The DC4sx uses razor-sharp vinyl cutting knives. The knife blades may cause serious personal injuries if handled without proper caution. Use extreme care when operating the cutter; and when installing, removing or handling the cutter's knife blade!

1.8.1 Removing the drag knife

1. Loosen the head clamp screw (1), swing the clamp arm back and remove the knife holder from the clamp (2).

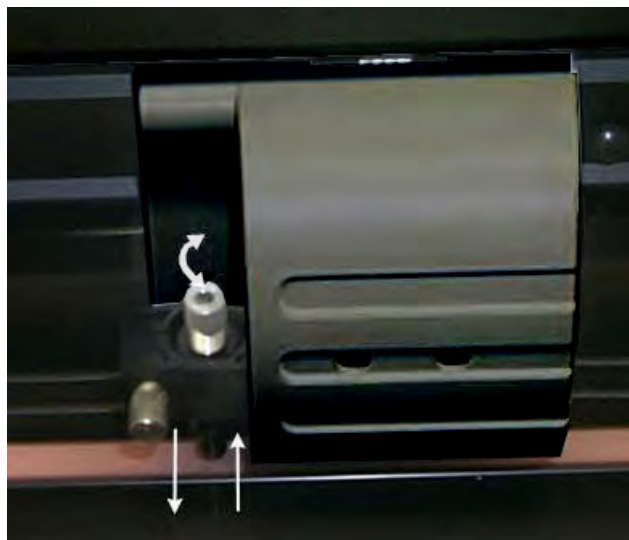

FIG 1-21
REMOVING THE DRAG KNIFE HOLDER FROM THE CLAMP

2. Turn the knurled adjustment knob (3) clockwise to push the knife (4) out of the holder (5).

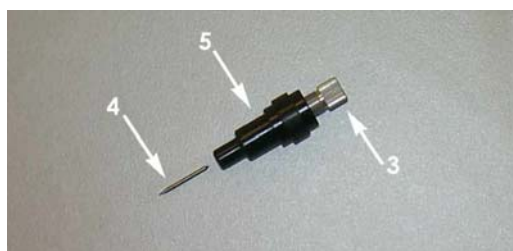

FIG 1-22
REMOVING THE KNIFE FROM THE STANDARD DRAG KNIFE HOLDER

3. Carefully pull the knife from the holder.

1.8.2 Installing the drag knife

1. Remove the aluminum plunger from the plastic knife holder (5) by turning the knurled adjustment knob (3) counterclockwise until the plunger comes out of the holder.
2. Insert the conical, non-cutting end of the knife into the opening in the narrow end of the holder; gently push the knife all the way in.
3. Turn the holder upside down and tap it lightly on a solid surface to ensure that the knife is completely inserted.
4. Slowly turn the knurled knob clockwise until the tip of the blade extends the distance required for the desired cutting media (t) as shown in figure below.

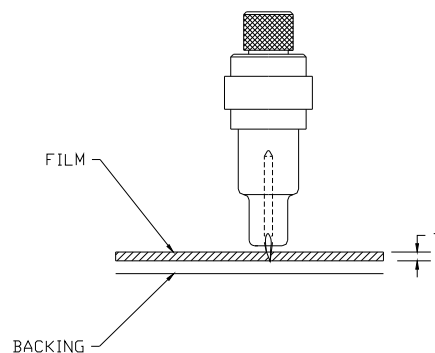

FIG 1-23
KNIFE LENGTH ADJUSTMENT

5. Insert the knife holder into head clamp, seating it firmly.

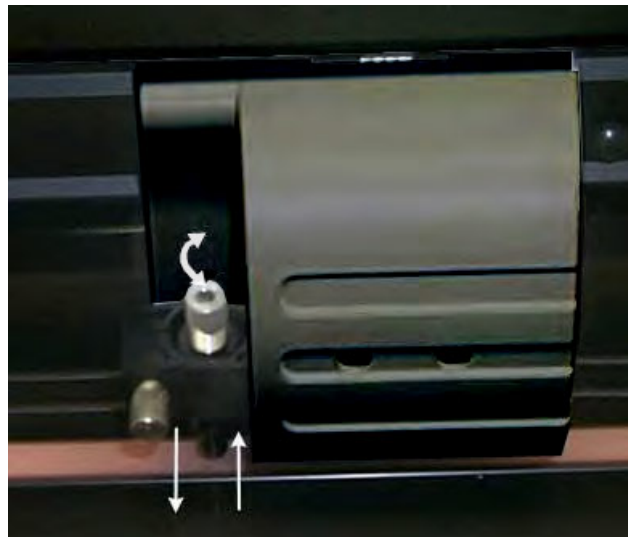

FIG 1-24
CLAMP DRAG HEAD

6. Close the clamp and tighten the clamp screw.

2.1 The control Panel

Figure 2-1 shows the control panel of the DC4sx. The most used functions of the LCD and the control panel keys are explained in the following paragraphs.

It is advised not to touch the control panel while the machine is printing or cutting, except for canceling the current job.



FIG 2-1
DC4SX CONTROL PANEL

2.1.1 The liquid crystal display



The liquid crystal display (LCD) contains 4 lines of 20 characters. The LCD provides DC4sx status information during operation and displays menu options for the configuration of the DC4sx.

WARNING

Each keystroke can initiate an internal test or movement of head or media.
Keep fingers and other body parts away from the cutting area.
There are hazardous moving parts.

The various menu and submenu items are always presented in a loop, which means when the last menu or submenu item is displayed, pressing the appropriate key will automatically take you back to the first item of the same menu or submenu.

2.1.2 The and key

The function of the  and  key depends on the current status of the DC4sx. The bottom line of the LCD displays the function of the keys between brackets if available.

2.1.3 The key

The  key returns back a step in to the previous menu level. To get at the top level of the menu, press this key three times. The DC4sx will also then be ready for printing if media is loaded.

2.1.4 The key

The  key toggles the status of the clamps. This key works only when the 5DC is in a ready state. There are three "Clamps". The left clamp on the rotating base and the pinch rollers. All clamps serve to hold the media in place while printing and transport media forward and backward.



The LCD prompts the user for a loading procedure when the clamps are raised.



2.1.5 The arrow Keys

The use of the arrow keys varies according to the operation in progress. For example: when working with different sub menus, the arrow keys select the next or the previous submenu.

Values in a submenu can be changed by pressing the  or  arrow keys.

When the DC4sx is in normal operation, pressing  or  moves the media backward and forward.

It is recommended never to move the media backward for printing on unused parts of the media. The imprints the sleeves make on the backing of the media make it impossible for the machine to be able to have correct tracking. Printing the calibration routines (see paragraphs 2.3 – 2.5. on used media (with tracking imprints on the backing) is **not** done. If they are done on used media, then the printer will loose the correct calibration settings.

2.2 How to Set printing Density

Print density refers to the level of energy being sent to the printhead. If the density is too low, the transfer will be incomplete (less than 100%). If the density is too high, the colors will become matted and washed out. Or, the ribbon may start to wrinkle.

The density setting cannot be used to make the printer darker or lighter. Print densities change between different media types because energy is absorbed differently, depending on the vinyl formulation, liner, etc.

Setting the print density:

1. Power on the printer and load media (see section 1.6.1).

2. Press the  key.

The printer menu will appear on the LCD.

3. Press the  key.

The printer menu will open and first menu item will appear on the LCD.

4. Press the  key.

*The density will appear on the LCD display, the active setting is marked with an *.*



5. Press the  key for a test of the density setting for standard printing or press the  key for a test of the density setting for high resolution printing. The test is printed in the current OptiTrac color (see section 2.3).



FIG 2-2
INTERNAL DENSITY TEST



1: If the density is set too high then in area 1 the ribbon will stick too long to the media while printing and leave matt areas behind.

2: If the density is set too low, then this area will not be 100% black

3: If the density is set too high, then this area will be darker than 95% cyan, the white holes will become filled randomly.

4: If the density setting is too low, then the lines will not be printed evenly.

The density test is optimized for cast vinyl. Other types of vinyl might result in conflicting results, which means that the media is probably less suited for thermal transfer printing.

6. Press the  key to lower the density or press the  key to lower the density if necessary. Press  to store new value.

An asterisk () will appear to confirm the new value is saved.*

7. Repeat test to check new setting and adjust more if necessary.

2.3 How to Set Media Tracking Parameters

The DC4sx prints and measures small lines, located at each side of the print, to optimize the tracking performance. After each printing pass, the media is advanced and those small lines are read by a sensor to align the consecutive printed passes.

The same sensor is also used to straighten the loaded media in the load direction.

Each time the media type or the color of the OptiTrac lines is changed, a recommended line feed must be performed (see section below). Failing to do so may result in poor print quality.

Choosing OptiTrac color

1. Power on the printer and load media (see section 1.6.1).

2. Press the  key.



The printer menu will appear on the LCD.

3. Press the  key.

The printer menu will open and first menu item will appear on the LCD.

4. Press the  key until the OptiTrac menu is visible on LCD.

*The OptiTrac menu will appear on the LCD display, the current color is marked with an *.*

5. Press the  or  to change the OptiTrac color. Press  to store new value.

An asterisk () will appear to confirm the new value is saved.*

Be careful with OptiTrac colors which have a large red component in them, they can usually not be used because the sensor cannot detect them as it reads them as white. It is not recommended to use such colors.

It is recommended to set OptiTrac to automatic, markers are then always printed on the far right side of the media (there were it is calibrated – see next procedure).

6. Proceed with line feed calibration (step 4 in next procedure).

Line feed calibration



1. Power on the printer and load media (see section 1.6.1).

2. Press the  key.

The printer menu will appear on the LCD.

3. Press the  key.

The printer menu will open and first menu item will appear on the LCD.

4. Press the  key until the linefeed test menu is visible on LCD. Press the  key.

The line menu will appear on the LCD display, there is a choice between a recommended test and a simple test.

5. Press  to initiate the recommended test.

A test pattern is printed and then cut out. Then the DC4sx calibrates the OptiTrac sensor and then completes the line feed test. The printed lines are measured and then internal parameters are adjusted automatically. If the DC4sx has to compensate too much, it will prompt the operator to redo the test. A simple line feed calibration test will suffice then.



FIG 2-3
RECOMMENDED LINE FEED CALIBRATION TEST



FIG 2-4
SIMPLE LINE FEED CALIBRATION TEST

Head alignment:

The two parameters above control the alignment in the media direction. There is also a calibration in the direction of the movement of the head. This is calibrated mechanically when a head is changed and should not be redone until the head is replaced again. However due to different media parameters (difference in media roll up tension, thickness of media) there might also be need for an extra calibration in the direction of the movement of the head.

Automatic head alignment setup:



1. Power on the printer and load media (see section 1.6.1).

2. Press the  key.

The printer menu will appear on the LCD.

3. Press the  key.

The printer menu will open and first menu item will appear on the LCD.

4. Press the  key until the head alignment test menu is visible on LCD. Press the  key.

The line menu will appear on the LCD display, there is a choice between a manual test and an automatic test.

5. Press  to initiate the automatic head alignment.

A test pattern is printed. Some printed lines are measured and then internal parameters are adjusted automatically. If the DC4sx has to compensate too much, it will prompt the operator with following text: "VALUE OUT OF RANGE ALIGN HEAD MECHANICALLY". If so, then a mechanical calibration, as described in the head change procedure, will need to be redone.



FIG 2-5
AUTOMATIC HEAD ALIGNMENT TEST

Note: Never do a manual head alignment test after an automatic head alignment test, because it defaults the automatic head alignment calibration parameters.

2.4 How to set the main knife parameters:

There are two important knife parameters, the offset and the knife pressure. The knife offset is a knife depended parameter. The knife pressure is a media depended parameters.

Each time the media type is changed, the knife pressure has to be checked each time media type is changed.
The knife offset needs to be checked each time the knife is changed.

Setting the knife pressure (cutting depth):

1. Power on the printer and load media (see section 1.6.1).

2. Press the  key and the  key until cutter menu is visible.

The cutter menu will appear on the LCD.

3. Press the  key.

*The cutter menu will open and the knife pressure will appear on the LCD display, the active setting is marked with an *.*

4. Press the  key.

A knife depth test pattern as shown below will be cut out.

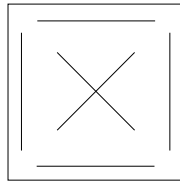





FIG 2-6
KNIFE DEPTH TEST PATTERN

The knife depth is correctly set when the test pattern is visible on the front side of the media backing, but not on the rear side of the media backing.

5. Increase the knife pressure using the  key when the cut pattern is not visible on the front side of the media backing.
6. Decrease the knife pressure with the  key when the cut pattern is visible on the rear side of the media backing.
7. Press the  key save and do a new test or the  key to save the changed setting.

In general, you should increase the knife depth and knife pressure when using thicker vinyl types.

WARNING: Do not operate the cutter if the knife blade cuts through the media backing, as this will seriously damage the cutter's rubber cutting strip and the knife.

Setting the knife offset:

1. Power on the printer and load media (see section 1.6.1).

2. Press the  key and the  key until cutter menu is visible.

The cutter menu will appear on the LCD.

3. Press the  key.

*The cutter menu will open and the knife pressure will appear on the LCD display, the active setting is marked with an *.*

4. Press the  key.

*The knife offset will appear on the LCD display, the active setting is marked with an *.*

5. Press the  key.

A knife offset test pattern as shown below will be cut out.

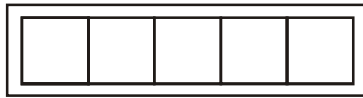
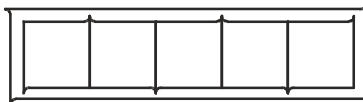



FIG 2-7
CORRECT KNIFE OFFSET PATTERN



When the knife offset is too low, the test pattern looks like this and the knife offset will have to be raised:



When the knife offset is too high, the test pattern looks like this and the knife offset will have to be lowered:



6. Increase the knife offset using the  key, decrease the knife offset with the  key.

7. Press the  key save and do a new test or the  key to save the changed setting.

2.5 How to calibrate print and Cut

The print head and the cutting head have each their own origin point. Perform the following test to align the both origins so that the contour cuts are not offset.

Each time the knife is replaced or media type is changed, then the print and cut calibration has to be done.
Only do a print and cut calibration if the media tracking and knife parameters are set correct (see section 2.3).

Print and cut calibration:

1. Power on the printer and load media (see section 1.6.1).
2. Start Summa Printer Control (See section 6.2).
3. Click on Tests -> Internal tests -> Print & Cut calibration.

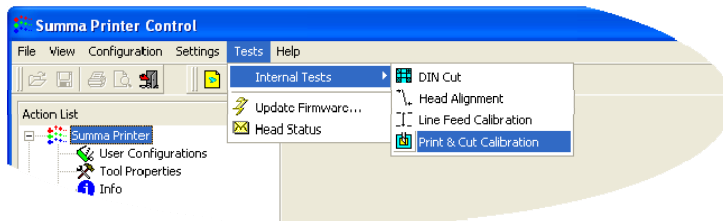

The DC4sx first prints and cuts out a test pattern similar to the one below. Weed out the large rectangle, and then search in each set for the small square where the printed lines are not visible.



FIG 2-8
CPRINT AND CUT TEST PATTERN

4. Now insert the values, which correspond to those squares into the DC4sx via the control panel. The 4 parameters can be changed between -16 and +16 even though only 8 steps are printed out in the test. If the values were too far off, then it is advised to redo the test.

If the optional hard disk is installed in the printer, then this test can be done directly from the keypad. It is the test just after the line feed test (see paragraph above).

2.6 How to Change the User (Quick Parameter Change)

The DC4sx printers include 16 user configurations, all of which consist of the same parameters. Each configuration can have unique parameter settings. This allows the printer to be quickly and easily reconfigured for different types of jobs or media.

It is recommended to change the user instead of doing a calibration when changing media type.

Changing the User Configuration:



1. Power on the printer.

2. Press the  key and the  key until.

The Select User Config menu appears on the LCD.

3. Press the  key.

*The Select User Config menu will open and current user configuration will appear on the LCD display, the active setting is marked with an *.*

4. Push the  or  key to change the configuration. Push the  key to confirm the selection.

1. TIP: Use easy names to quickly recognize what each user is configured to do.

2. Some names are already predefined in the factory.

Some extra predefined users can be found on the DC4sx CD under the subdirectory 'users' send them to the DC4sx with Summa Printer Control. Open Summa Printer Control, Click on , select the appropriate file and send it (see section 6.2).

Be careful these predefined users will overwrite the current user parameters. It is advised to start from 16 down when creating your own.

2.7 How to Change media width

2.7.1 Placing of the pinch roller

The DC4sx has two positions for the right pinch roller. The recommended roll widths are: 61 and 76 cm (24 and 30 inch).

The printer remembers always the last loaded media width (even when machine is switched off) regardless of the chosen user. If a different size of media is loaded, then the DC4sx will prompt the user to check the right pinch roller position (**MEDIA SIZE CHANGED CHECK RIGHT PINCH ROLLER POSITION**). Press to continue and change pinch roller position if necessary.

The line feed calibration (see section 2.3) depends on the loaded media width. The line feed parameters are stored per user and it always indicated with a letter in the upper right corner of the LCD for which media width the current user is calibrated. (L for 76cm - 30inch; s for 61cm – 24inch).

If a job is sent to the DC4sx and the loaded media width is not calibrated with the correct line feed, then the DC prompts the user with the message: **WARNING: USER IS NOT CALIBRATED FOR THIS MEDIAWIDTH.**

Pressing continue will clear this remarks and the DC4sx will continue printing, however it is recommended to quit the job and either calibrate this user with the correct line feed test for the loaded media or to change to a user with the correct settings for the loaded media.

It is recommended to calibrate certain users for specific widths of vinyl and to change user when media width is changed. Not changing user when changing media width will finally result in wrongly calibrated users and bad print quality.

When calibrating a certain user for a specific width, then do the print and cut calibration (see section 2.5) right after the line feed calibration. This calibration is also depended of the loaded media width.

2.7.2 Using non recommended media widths.

Some extra fixed line feed tests have been developed in order to work with rolls of vinyl which do not have the recommended width. It does NOT mean however that using these materials will perform within the regular Summa specifications of tracking and accuracy.

When non-recommended rolls widths are used, then it is advised to add white to the design so that the size of the print-out matches the size of the used fixed line feed test.

Those line feed tests can be sent to the printer by using Summa Printer Control. (see section 6.2) The fixed line feed tests are found in the subdirectory 'Testfiles' of the installation directory of Summa Printer Control and can be recognized because they have the word 'fixed' in their filename

2.8 Preparing the DC4sx for long print-outs

The DC4sx has a fixed position at the rear for the rollguiding of the flange. It is possible that some types of vinyls are not wound up even (e.g. the core sticking out). This results in a forcing of the path of the vinyl in a wrong direction. Following procedure can help to solve that problem:

1. Load media in the machine as described in section 1.6.1.
2. Print out a small test of 2 or 3 band-passes high.

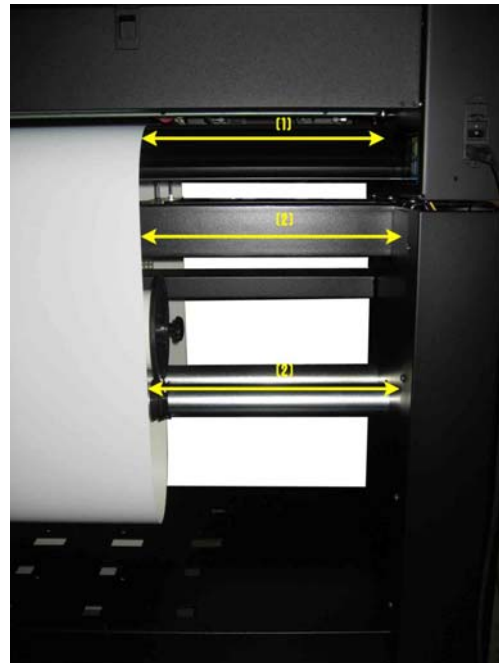
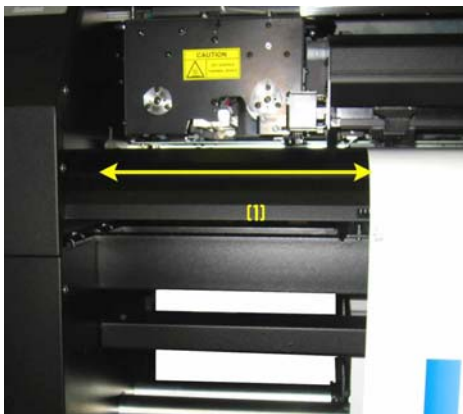

FIG 2-9
REPOSITIONING ROLLER GUIDE

3. Check the path of the media. The distances, marked with the white arrows and the same number, should all be the same. The middle arrow of the second photo points to the roll itself
4. If not, check first if the media has moved from its place of origin. If so reload with a maximum loop at the back.
5. If it did not move, then reposition the rollerguide, so that the path of the vinyl is as shown above. Make also sure that the flange is flush to the core.

3.1 Contour cutting

There are two possible ways to contour-cut with the DC4sx.

Normally the cutting is done automatically direct after the job is printed. The Rip recognizes the contour lines splits up print and cut data, sends first the printing data to the DC4sx and then the cutting data.

The DC4sx has also an accurate Optical Positioning System. This can be used when it is impossible to contour-cut right after the printing. For instance when the design has to be laminated and then cut afterwards. OPOS is based on the principle of registrating printed squares around the design. The registration of those markers is done by a sensor on the front of the printer carriage (same sensor that is used for the OptiTrac system). To be sure that OPOS works accurately, the distance between the sensor and the knife tip must be calibrated (see section 2.5)

3.1.1 Making the design

The orientation shown in this figures is as it will be seen on the computer screen when the design is created. When the design is exported and printed out with SCC, then orientation on the printer is rotated by 180%.

Create the design and contour line. For easier handling, place the contour lines on a different layer (they will have to be cut out afterwards).

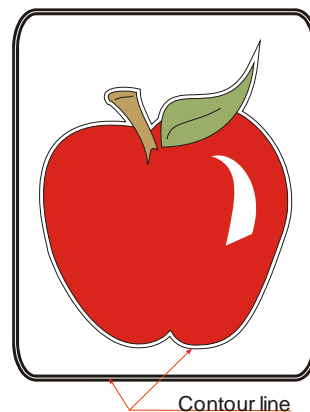

FIG 3-1
DESIGN WITH CONTOUR

When defining contours, do not define them exactly on the border of the design! It is advised to leave either a white space between the contour and the design, or to define the contour inside a thick outline. Or better yet, just inside the design. If the contour is designed right on the edge of the drawing, then the slightest misalignment will result in a bad result.

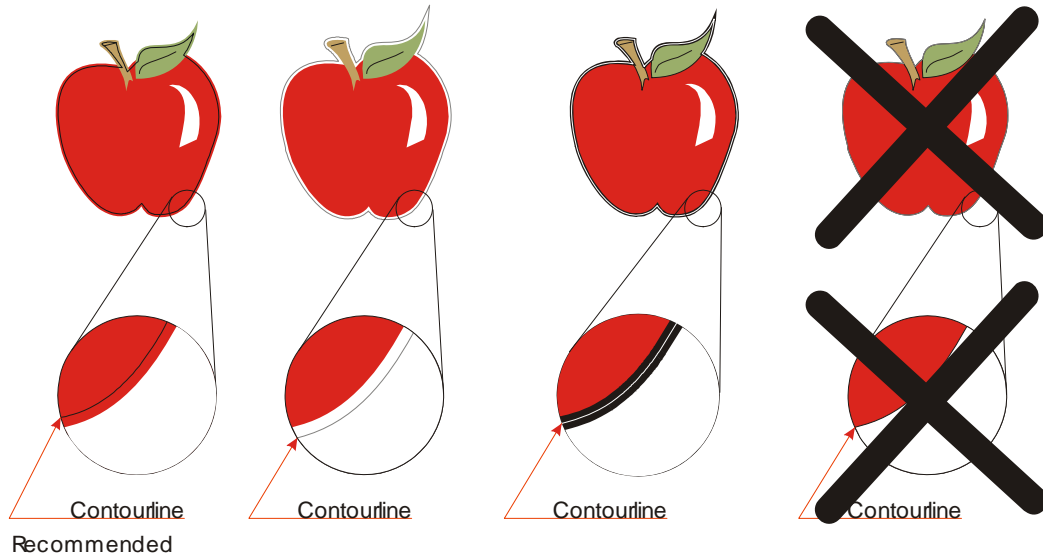

FIG 3-2
ADVISED PLACES FOR CONTOUR PLACEMENT

3.1.1.1 Contour cutting

Define the line that needs to be cut as a special color that the RIP recognizes as an object to be cut.

When using Summa Color Control (see section 0) it is advised to use the spot color palette and the spot color CONTOUR. Summa Color control print then first the other objects and afterwards the objects which have as color CONTOUR will be cut automatically.

Send the job with the RIP to the DC4sx

3.1.1.2 OPOS cutting

When the printed job has to laminated before cutting, then follow this procedure

- Put the OPOS markers around the drawing. In your design the top right corner is the origin of the design that will be printed out.
- Place the origin marker at the right side and above all contours that need to be cut.

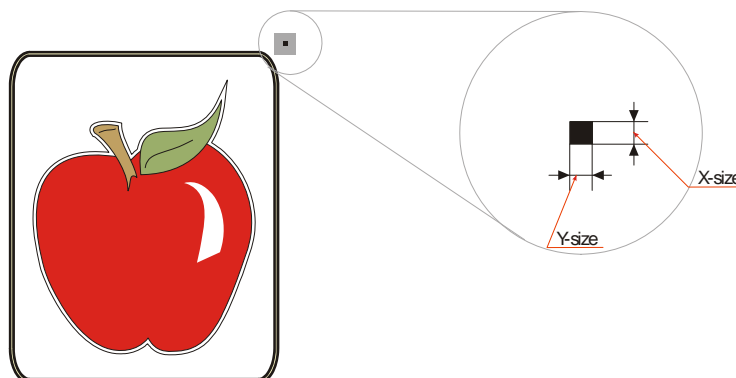

FIG 3-3
PLACEMENT OF THE FIRST (ORIGIN) MARKER

The marker must be a square. The advised size is 3mm and the line style of the marker is best set to none (line styles with a certain thickness affect the precision).

Make sure that around every marker a 'white space' which is 3-4 times the size of the marker.

- Place rest of the markers.

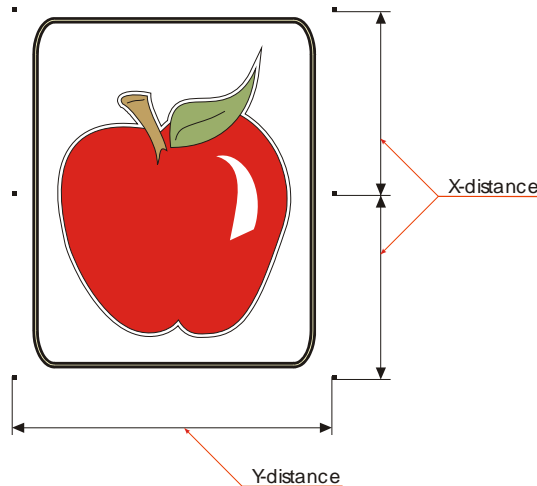

FIG 3-4
PLACEMENT OF THE REST OF THE MARKERS

- First place copies of the origin marker at a regular distance in the up/down direction. The last marker at the bottom must be under all contours that need be cut. This direction will be referred to as the X-direction.

Make sure there is enough white space around every marker.

The advised X-distance (distance between two consecutive markers) depends on several items. Normally 30 to 40 cm is a recommended distance.

If the marker size is smaller than 3mm, lower the X-distance.

If the white margin is critical, lower the X-distance.

The bigger the distance between the markers, the faster the registration of the markers works. The smaller the distance between the markers, the more accurate OPOS works, however the influence on the accuracy is rather small.

The distance between the different markers must be the same

- Make a copy of the row of markers and place them left to the design.

Make sure the left row is not shifted in the up/down direction in reference to the right row of markers.

- Make the layer on which the contour lines are invisible and not printable.
- Print the design together with markers on the DC4sx.

Make sure not to scale or rotate the design in the RIP.
Leave at least 30cm after the design.
Leave the front edge also to the design.

It is advised to group the jobs on a roll, since with each sheet there needs to be rear margin of +/- 30cm

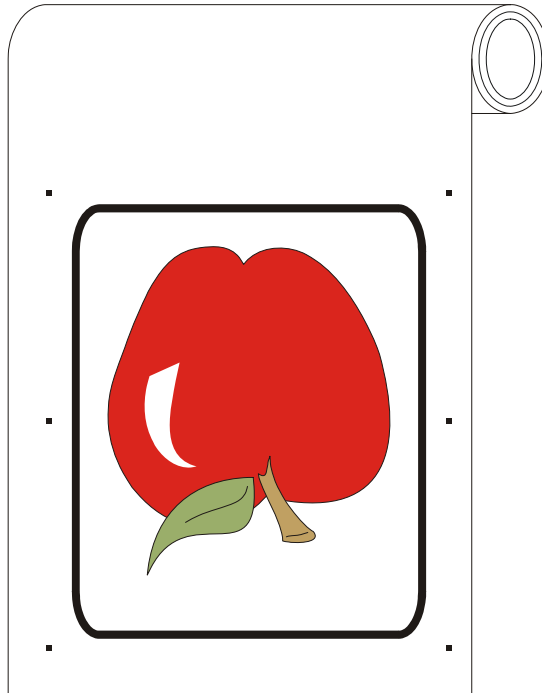

FIG 3-5
PRINTED DESIGN

3.1.1.3 Making cutting data ready

- Make the layer on which the contour lines are visible and printable. Do the opposite with the print data.
- Make sure that the origin marker (top right) is also defined as a contour. This will be used as the origin for the cutting.
- It is recommended to use WinPlot for sending cutting data to the DC4sx. WinPlot also sends the OPOS parameters automatically to the DC4sx. Just click on the OPOS cut icon and the parameters will be sent to the DC4sx and the special load will be activated (the machine will ask the user to put the knife tip above the first OPOS marker. When using WinPlot, then the orientation of the design loaded in the DC4sx must be the same as the orientation on screen in WinPlot.

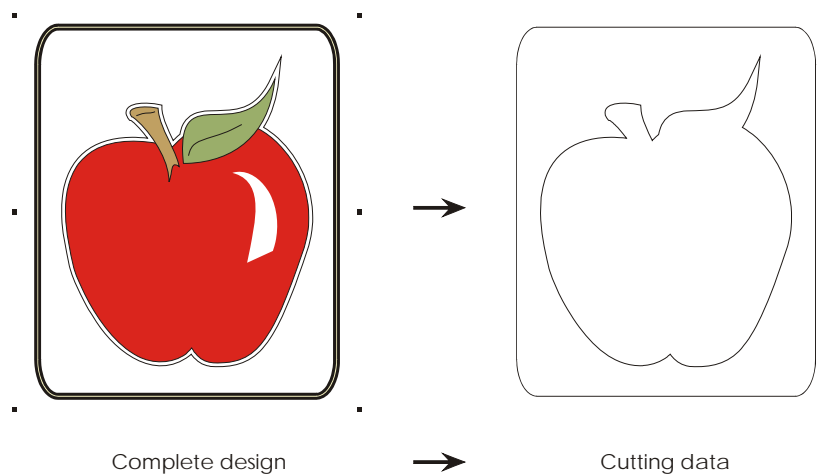

FIG 3-6
SELECTING CUT DATA

3.2 Cutting trough

The DC4sx can also cut through both vinyl and backing. This is done with the option FlexCut.

FlexCut can be set to OFF, Fast, or Accurate. When the cutter is set to Fast or Accurate, it will alternately cut a certain length with full pressure, and a certain length with reduced pressure. The advantage of the FlexCut feature is that it cuts completely through the material, yet allows the material to stay together by means of the small media bridges.

Fast is the quickest mode, but it is less precise due to the pressure changes during the cutting.

Accurate is much slower, but much more precise, as the cutter stops at every change of pressure.

There are 4 typical FlexCut parameters:

1. *Full pressure pressure*: This parameter determines the maximum pressure. This is the pressure at which the knife cuts completely.
2. *Full pressure cut length*: This parameter determines the length that is cut with full pressure, usually the length that will be cut all the way through.
3. *Flex pressure cut length*: This parameter determines the length that will be cut with reduced pressure or without pressure. This is usually a much smaller value than the full pressure cut length – this is the length of the media bridges.
4. *FlexCut pressure*: This parameter determines the pressure of the Flex pressure cut length. This is usually a reduced pressure so that the knife only scratches the media or cuts it only halfway through.

Some print&cut software can recognize the difference between a contour line and a cut-through line. The software sends then first the data of the contour lines to the cutter, and then it activates FlexCut mode and sends the data for cutting through to the cutter.

If the cutting software cannot do this, then the user needs to first send the data of the contour lines separate, set the cutter manually in FlexCut mode and then send the data for cutting through.

Note: Often, it is difficult to find the correct balance between cutting deep enough making sure the pieces can be taken out easily, and not cutting too deep making sure the material keeps its strength while cutting. Sometimes this balance doesn't exist meaning that this material can't be cut through.

Note: When cutting through, it is recommended that parallel lines are at least 1 cm away from each other. Otherwise, while cutting the second line, the first line may come loose and cause trouble.
FlexCut wears down the cutting knife fast.

4.1 Introduction

This section is a detailed list of all parameters that can be changed and tests that can be initiated from the touch screen. This section may be used as a reference for locating a certain setting or test.

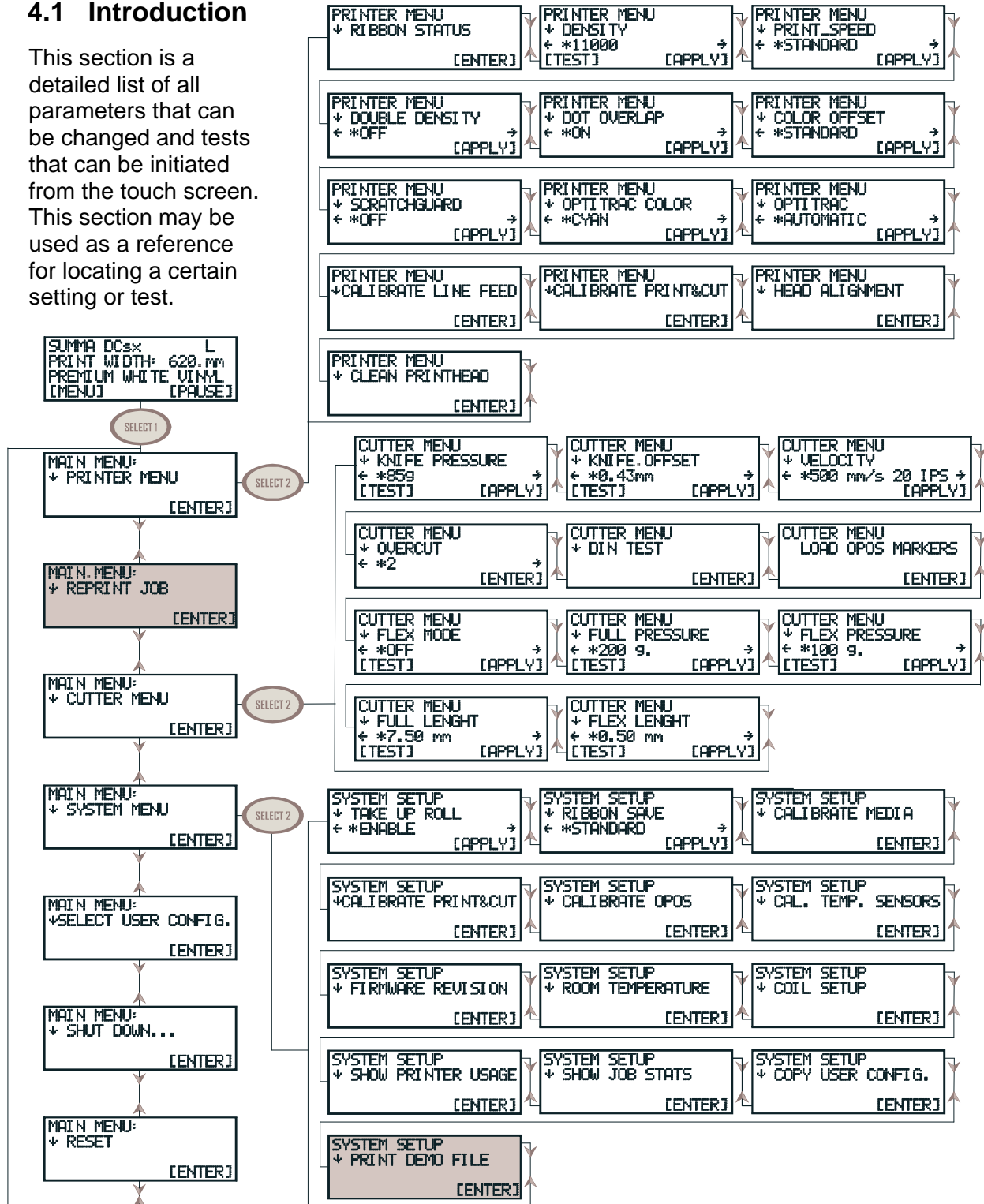





FIG 4-1
COMPLETE MENU STRUCTURE

4.2 Main menu







The main menu can be entered when [MENU] is visible on the bottom line of the LCD. Press the  key to enter the main menu. The main menu items give access to submenus or commands. Press the  or  key to go from one menu item to another.

4.2.1 Printer menu

Pressing  enters the printer menu. The printer menu is explained in section 4.3.

4.2.2 Reprint job

This menu is only accessible if the hard disk option is installed.

The DC4sx then stores every sent job on hard disk. If the hard disk is almost full, the oldest jobs will be deleted. After pressing , press the  or  key to scroll through the saved jobs. Push the  or  key to change the amount of copies that need to be reprinted. Push the  key to start reprinting the chosen job. Pressing  removes all jobs from the hard disk.



4.2.3 Cutter menu

Pressing  enters the cutter menu. The cutter menu is explained in section 4.4.

4.2.4 System setup

Pressing  enters the system setup menu. This menu is explained in section 4.5.

4.2.5 Select User Configuration

The DC4sx stores 16 user configurations. Push the  or  key to change the configuration. Push the  key to confirm the selection. On the LCD, the active user is marked with an * (asterisk).

The user configurations are setup to quickly change several parameters depending on the type of vinyl or kind of job.

4.2.6 Shut down....

After pressing , the DC4sx removes any cassette from the carriage, closes any open files on the hard disk and raises the pinch rollers. It is advised to use this key when shutting down the DC4sx, especially for minimizing wear on the pinch rollers. If the pinch rollers are left down for a long period of time, a flat spot is created on the wheel and tracking becomes a problem and is not guaranteed any more. The pinch rollers are automatically raised when the DC4sx is idle for more than 4 minutes.



4.2.7 Reset

When pressing , the DC4sx will reset. This reset is usually used for canceling current print jobs or canceling non-fatal errors or alarms. A reboot will be necessary after a reset.

4.3 Printer menu

The printer menu contains parameters and small routines to optimize the printing quality.

4.3.1 Ribbon status

The RIBBON STATUS sub-menu is used to check the status of the cassettes and their locations. Press the  key to enter the sub menu. Now the status of each cassette and location can be checked. Press the  or  to scroll through the different locations.

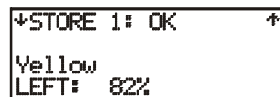

```

↓STORE 1: OK ↑
Yellow
LEFT: 82%
  
```



FIG 4-2
STORE STATUS

The first line shows the current selected location. When there is no cassette in the station, instead of "OK", the LCD will read "EMPTY" and the remaining LCD will be empty. The third line displays the color of the ribbon. On the bottom line, the amount of ribbon remaining in the cassette can be read. This amount is only an approximation of the actual length in the cassette.



4.3.2 Density

Print density is explained in section 2.2. When the hard disk option is installed, then the density test is printed in three colors instead of monochrome.



4.3.3 Print Speed

Print speed refers to the speed of the printhead. With the  or  key the speed can be raised or lowered. Press the  key to confirm. Lowering speed will reduce banding. Raising speed will reduce wrinkling on certain (usually non-approved) media.

4.3.4 Double Density

Double density is a special printing mode. This mode enables the DC4sx to print on a much wider range of materials. When printer is in double density mode, then the speed settings have no effect on the printing speed any more. Double density can be set to ON or OFF by pressing the  or  key. Then press  to confirm.

4.3.5 Dot overlap

The DOT OVERLAP sub-menu is used to activate or deactivate the dot overlap. When the DC4sx prints the next pass of an image, the last dot on the edge of the previous pass is reprinted. Dot overlap can be set to ON, OFF or HALF by pressing the  or  key. Then press  to confirm. It is advised to set dot overlap to ON. When printing with a mask (see 6.3.11), set it to HALF. On the LCD display, the active setting is marked with an * (asterisk).

4.3.6 Color Offset

The COLOR OFFSET sub-menu is used to set the color offset feature. While printing, the DC4sx shifts each color plane 8 dots (STANDARD). This is to blend the printed strips together more gradually. The figure below shows how offset color plane strips are printed. Color offset can be increased (16 dots: HIGH) or disabled (0 dots:

DISABLED) by pressing the arrow keys. Then press  to confirm. It is advised to set color offset to STANDARD.

On the LCD display, the active setting is marked with an * (asterisk).

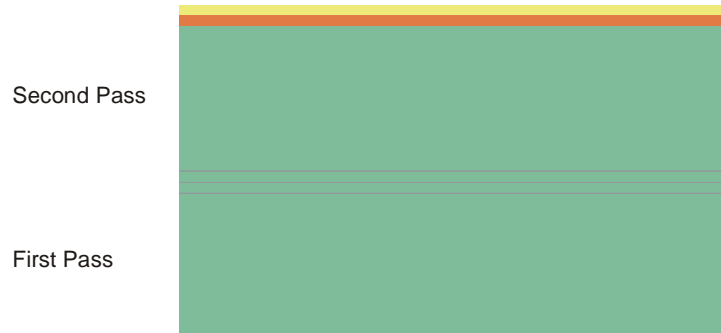



FIG 4-3
COLOR OFFSET

4.3.7 ScratchGuard

The option Scratch guard makes it possible to put a layer of protective coating on the printed images. Scratchguard can be set to ON or OFF by pressing the  or  key.

Then press  to confirm.

4.3.8 OptiTrac™ Color

The DC4sx prints and measures small lines, located at each side of the print, to optimize the tracking performance. The color of these lines can be changed within this menu. Be sure to use colors that are in contrast with the vinyl color. The menu option to change color is useful when printing monochrome, or on colored vinyl. The default value for white vinyl is cyan.

If white, gold or silver is chosen as OptiTrac™ color, then the DC4sx will raise the head between the left and right OptiTrac™ mark if the color is not used. With all other colors, it will keep the head down.

4.3.9 OptiTrac™

This menu allows setting the OptiTrac™ feature to automatic, ON, OFF or white background. The default setting is automatic, which means the OptiTrac™ lines are omitted when the height of the design is less than one print pass wide (98mm). Setting this option to ON means the lines are always printed.

OFF is used for special media on which the markers can't be read. This means that the line feed has to be done manually and that there will always be a relative large overlap.

White background is used to accentuate the markers more (dark media) and to mask reflective particles in the media. This is normally only used if white ribbon was already used in the design. The media is not automatically aligned when using this option.

4.3.10 Calibrate linefeed

The calibrate linefeed test is used to calibrate the media feed. It is advised to do this test each time a vinyl roll is changed. This test is fully automatic. It is explained in section 2.3.

4.3.11 Calibrate Print&Cut

When the Hard disk option is installed, then this test can also be performed directly from the keypad. The calibrate print&Cut calibration is explained in section 2.5.

4.3.12 Head alignment test

When the Hard disk option is installed, then this test can also be performed directly from the keypad. Otherwise this test has to be started from Summa Printer Control. The head alignment test is used to check if the carriage is aligned (mounted) correctly on the DC4sx. This test should only be performed after a head or a carriage change. Fig 4-4 shows the pattern that is printed using this test.

The lines must meet, in the middle, within a certain tolerance.

Please refer to document enclosed with spare head for more detailed info.

There are two head alignments one manual and one automatic. The manual one should only be done if a head is changed or if there is a mechanical mis-alignment, the automatic one should be used in all other cases.

The automatic test sets a user parameter; this means that this value is different for every user configuration.

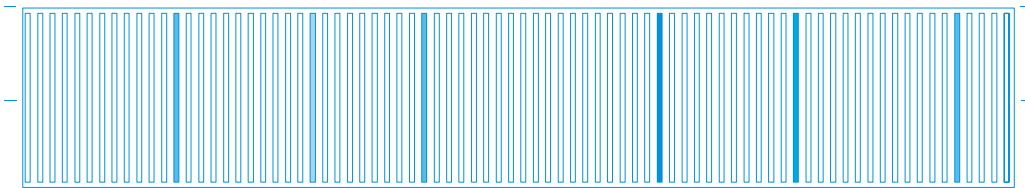

FIG 4-4
HEAD ALIGNMENT TEST



4.3.13 Clean printhead

This routine cleans the printhead. If the transfer of the ribbon has degraded, then this cleaning procedure will clean the printhead automatically. Also, the printhead is periodically cleaned while printing. Do not use this cleaning routine too often as it can prematurely wear down the printhead surface. This procedure cleans any build-up from the heat resistant layer, which is coated on the backside of the ribbon.

4.4 Cutter menu



The cutter menu contains parameters and small routines to optimize the cutting quality.

4.4.1 Knife pressure

The KNIFE PRESSURE parameter is used to set the cutting pressure of the knife. Press the  or  arrow keys until the desired pressure is displayed on the LCD, then press  to confirm.



The knife pressure can be set between 0 and 400 grams. Knife pressure set-up is explained in detail in section 1.9. On the LCD, the active knife pressure is marked with an * (asterisk).

4.4.2 Knife offset



The KNIFE OFFSET parameter is used to set the distance between the knife blade tip and the center axis of rotation. The default knife offset value is .45 mm. Press the  or  arrow key until the desired knife offset is displayed on the LCD and press  to confirm.

The value can be set between 0 and 1 mm. Make sure that the selected knife offset value matches that of the knife blade. Some fine-tuning may be necessary because of the mechanical tolerances on the knife. To verify the knife offset, a test can be cut by pressing the  key. If the offset value is set too low, the rectangles will not close. When the offset value is set too high, the rectangles will be distorted. On the LCD display, the active setting is marked with an * (asterisk).

4.4.3 Velocity

The VELOCITY submenu is used to set or modify the cutting velocity. The default velocity is 500 mm/s (20 ips). Press the  or  arrow keys until the desired speed is displayed on the LCD and press  to confirm. The velocity can be set between 50 mm/s (2 ips) and 600 mm/s (24 ips). On the LCD, the active plotting speed is marked with an *(asterisk).

4.4.4 Overcut

The OVERCUT submenu enables you to generate an overcut, in order to improve weeding the cut vinyl. Press the  or  arrow keys to change the value and press  to confirm. The default overcut is set to 2. The overcut setting can be disabled (=0) or set to any value between 1 and 10. Each unit is about 0.1 mm or 0.004 ". On the LCD, the active value is marked with an *(asterisk).

4.4.5 DIN test

The DIN TEST CUT performs an electrical and mechanical test of the cutter, in order to check the cut quality, but also provides the user with feedback on knife setting, knife pressure, knife offset and cutting depth.

This test cut is always a DIN A4 portrait/A-size image. This cut is always executed in the sequence prescribed by the ISO DIN standard.

Press the  key to execute.

4.4.6 Load OPOS Markers

This initiates the special load procedure to read the pre-printed markers. This feature is completely explained in chapter 6 of this manual.

Press the  key to execute and follow the instructions on the LCD.

4.4.7 Flex mode

Flex mode is explained in section 3.2. as well the individual parameters.

4.5 Setup menu

The setup menu contains parameters, tests and info on the DC4sx that are not often used.

4.5.1 Take-up roll



The TAKE-UP ROLL sub-menu is used to activate or deactivate the take-up rollers. The take-up rollers can be set to disable, print only job and print&cut job by pressing

the  or  key. Then press  to confirm. On the LCD display, the active setting is marked with an * (asterisk).

4.5.2 Ribbon Save

The RIBBON SAVE sub-menu is used to set the ribbon save mode. In STANDARD mode, a ribbon is used over the full width of the print job as soon as one dot is required in the print pass. No ribbon will be used if no ink is required in the print pass. In ribbon save mode HIGH, no ribbon will be used if no ink is required in the print pass and ribbon will also be saved as soon as no ink is required anymore on the right-hand side of the image.

With ribbon save mode HIGH, the printhead is raised inside the image. This may leave an impression in the vinyl causing print quality issues in the next print passes.

The ribbon save mode can be set by pressing the  or  key. Then press  to confirm. The default setting is STANDARD. On the LCD display, the active setting is marked with an * (asterisk).

4.5.3 Calibrate media

Calibrate media is used to optimize the parameters of the OptiTrac sensor. Press the  to perform the calibration. The DC4sx prints out the pattern below and starts a measuring procedure. A lot of numbers appear on the LCD, they are only there for the service technician.

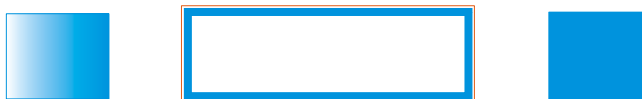



FIG 4-5
CALIBRATE MEDIA TEST

4.5.4 Calibrate Print&Cut

When the Hard disk option is installed, then this test can also be performed directly from the keypad. The calibrate print&Cut calibration is explained in section 2.5.

4.5.5 Calibrate OPOS

This test is used to calibrate the physical distance between the marker sensor and the knife tip. Press the  key to start the test. The DC4sx will cut out three rectangles. After that the machine will prompt the user to weed the three rectangles.

Do so and press continue (key ). The DC4sx will now measure the difference of the reflection level of the backing and the media. Then it will search the edges of the two outer rectangles. If the vinyl is not appropriate for the test, then the DC4sx will give a message. Then the test has to redone with a vinyl which has a high contrast between the media and the backing color.

4.5.6 Cal. Temp. Sensors

This test is used when a printhead is changed. This test is fully automatic after the  key is pressed twice.

4.5.7 Firmware revision

Pressing the  key will furnish the details on the DC4sx firmware revision. This information is often helpful to technicians when diagnosing problems over the telephone.

4.5.8 Room temperature

Press the  key and the DC4sx will display the room temperature.



4.5.9 Coil setup

This test is used to calibrate knife pressure and to set the knife "Landing". After adjustment, the value is saved in the system's memory. To execute this test, a tension gauge of ± 100 gr. and ± 500 gr. is required.

Press the  key to enter the test and follow the guidelines on the LCD screen.

Do not perform the coil test when the machine is working properly. Changing the parameters to incorrect values may seriously affect the quality, and may even damage the DC4sx.

4.5.10 Show printer usage







Pressing the  key will furnish the square meter / square feet amount of vinyl carried through the unit during printing. Pressing the  key will reset this counter to zero.

4.5.11 Show job stats

Pressing the  key will show the details on the last printed jobs. These include printing size, time and costs. The parameters for the cost have to be set with Summa Printer Control. There are 3 cost parameters:

1. Ribbon price = cost of a ribbon divided by 350 (ribbon length)
2. Vinyl price = cost of a roll of vinyl divided by the roll length.
3. Extra cost. This can be used to include the cost price of the printing head and if needed be write-off of the of other fixed costs.





4.5.12 Copy User Config.

This menu enables the operator to copy the parameters from one user to another user (see 4.2.5 for detail on which parameters). When copying the parameters, the user name is not changed. Press the  key start the copy process. With the  or  key the source user can be chosen. With the  or  key the target user can be chosen. Then press the  key to confirm or the  key to cancel.

It is recommended to change the user rather than doing a calibration when changing media type.

4.5.13 Print Demo File

This menu option is only visible if a hard disk is installed.

On the hard disk of the DC4sx there are two demo files. A print and cut file of 800mm by 380mm and a color chart. Press the  key to enter the menu. Then with the  or  key choose the demo file. Then press the  key to execute. The color chart was made with Corel 11, then exported using the generic CMYK printer profile and then ripped with the screening option set to printer default. Colors might differ slightly when using other settings in either CorelDraw or SummaColorControl.



5 Maintenance and Cleaning

5.1 GENERAL INFORMATION



The DC4sx has a number of sliding surfaces made of smooth metals and plastics. They are virtually friction-free and require no lubrication. They will, however, collect dust and lint, which may affect the performance of the DC4sx. Keep the DC4sx as clean as possible by keeping the front cover always closed. When necessary, clean the unit with a soft cloth dampened with isopropyl alcohol or mild detergent. Do not use abrasive cleaners.

The printing surface is made out of a special cellular material. Do not touch it! Cleaning it with any kind of fluid will permanently damage it. Also if pressure is applied to the surface with anything other than the printhead, the printing surface could also be permanently damaged.

5.1.1 Cleaning the drive system

After time and usage, the sleeves of the drive drum may become clogged with accumulated residue from the media liner. This situation may affect traction, as the media will tend to slip between the pinch rollers and the drive sleeves.

→ To clean the drive sleeves, proceed as follows:

1. Power down the DC4sx and remove media and cassettes. Switch it back on.
2. Wait until it is initialized and open the front cover.
3. Cover the front and rear sensor with a piece of paper. Remove the backing from a piece of vinyl. Place the vinyl with the tacky side down between one of the pinch rollers and a drive sleeve.
4. Close the cover, press the  key twice, and wait until the machine is ready.
5. Open the cover and press the ▲ or ▼ arrow keys to move the vinyl strip, adhesive side down, back and forth. Be careful not to lose the strip within the machine. Press the  key again to release the pinch rollers.

The figure shows the front sensor covered and the vinyl strip between the pinch roller and the sleeve.

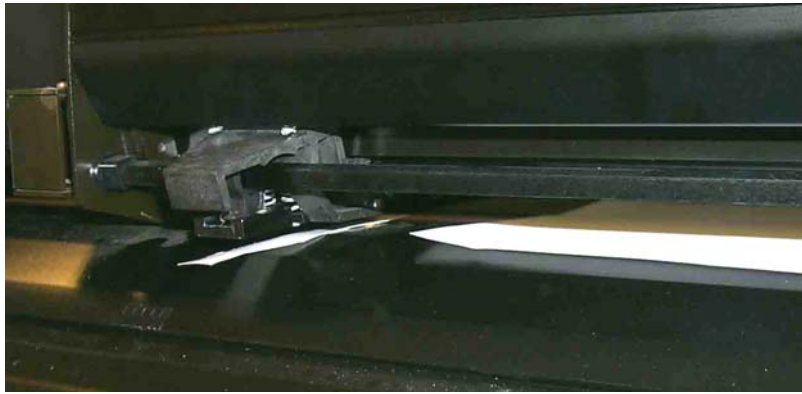

FIG 5-1
CLEANING THE DRIVE SLEEVES

5.1.2 Cleaning the media sensors

After a time and usage, the sensor may become dirty with accumulated residue from the media. This situation may cause malfunctioning of the DC4sx.

➔ To clean the sensor area, proceed as follows:

1. The front sensor is located on the DC4sx left side, right next to the pinch roller. The rear sensor is located on the same line as the front sensor but on the rear plate.
2. To keep the sensors clean, it is sufficient to wipe them out with a cotton swab.



FIG 5-2
POSITION OF THE FRONT AND REAR MEDIA SENSOR

5.1.3 Cleaning the cleaning pad

Located on the left side of the DC4sx is a printhead cleaning pad. The printer cleans the head periodically on this pad. It is possible that after a while some dust will accumulate on this pad. Therefore it is advised to clean this pad from time to time.

➔ To clean the cleaning pad, proceed as follows:

1. Take a piece of scrap vinyl that is a bit larger than the cleaning pad. Remove the backing and stick it on the cleaning pad.
2. Gently apply equal pressure on the vinyl, pressing the adhesive on the pad.
3. Remove the vinyl and check the back of the vinyl. If it is dirty do the procedure again, until the vinyl does not show dirt from the cleaning pad.

If the cleaning pad starts turning white, it is worn out and should be replaced.

The cleaning plate should be cleaned every week or after each change of roll vinyl which ever come first.

Every five rolls of vinyl, the cleaning pad should be replaced (or turned once – mark used side so it is not used twice).

Using not approved material can raise the need to perform these actions.

Cleaning pad should be changed if the printhead is changed.

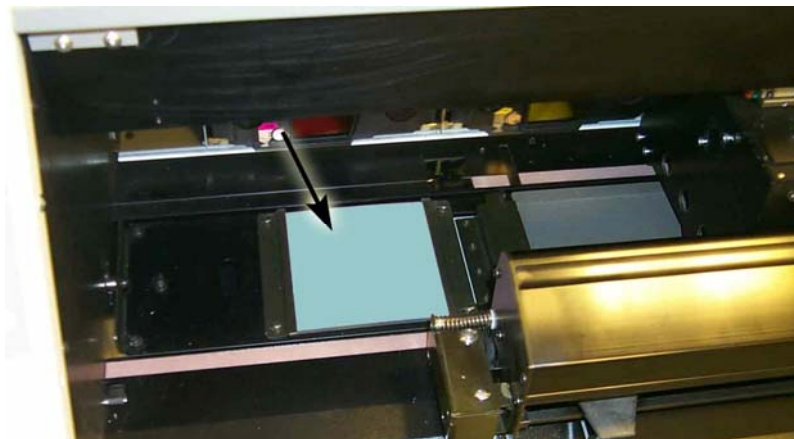

FIG 5-3
CLEANING PAD

5.1.4 Cleaning the printhead

The printhead accumulates dust, debris and resin residue, which can all degrade the print quality. The printer will automatically self-clean the printhead (see section 4.3.13). While this procedure removes much of the residue and debris, the printhead will sometimes require manual cleaning, particularly after a ribbon breakage because large pieces of ribbon material might be caught underneath the carriage.

Do not clean the printhead just after printing. The printhead is still hot after printing. Touching it too soon after printing might cause injuries.

Do not clean the printhead above the printing surface.

➔ To clean the printhead, proceed as follows:

1. Power off the DC4sx. Open up the rear cover and take out the cassette.
2. Use a lint free cloth, or gauze, moistened with isopropyl alcohol.
3. Gently wipe the printhead (1), the release plate (2) and the rollers (4).
4. Note the position of the ribbon end sensor (3).

Clean the printhead after every change of roll of ribbon.

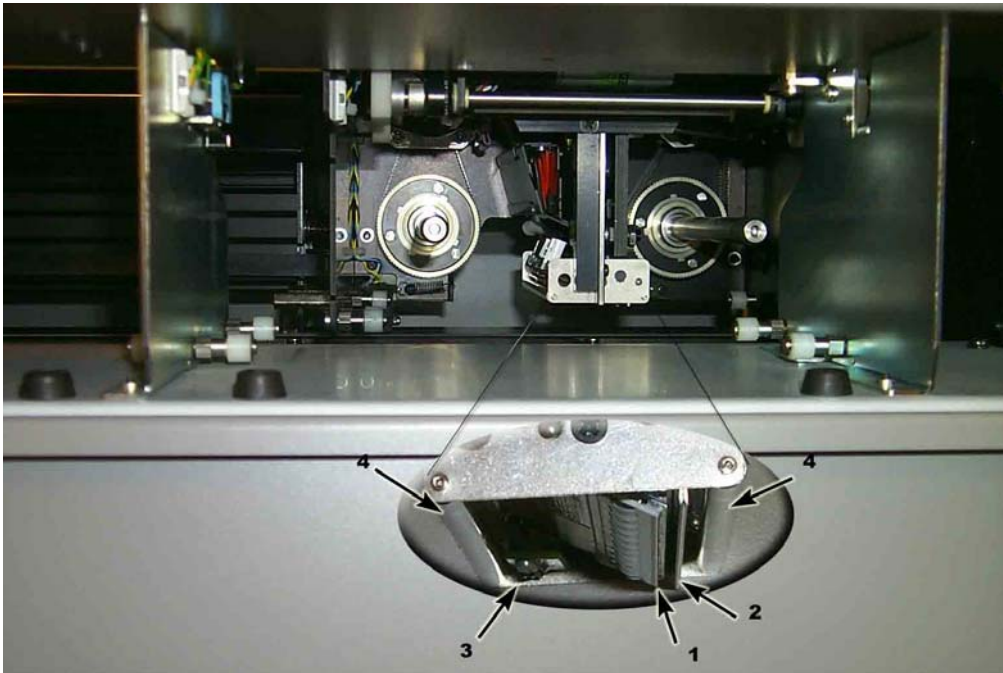

FIG 5-4
CLEANING THE PRINthead

5.1.5 OptiPrint™ cleaning system

The maintenance of the system is described in the installation guide which was packed separate in the accessory box.

5.1.6 Cleaning the printing surface

The printing surface is very delicate. It is made out of cellular material. Oil and moisture from fingers damages the surface, therefore great care should be taken when the printing surface is uncovered. **DO NOT TOUCH SURFACE.**

In rare cases it might be necessary to clean the printing surface. It is not recommended to do it, but sometimes it is the only safe way to remove dirt.

➔ To clean the printing surface, proceed as follows:

1. Power off the DC4sx and remove the vinyl.
2. Cut a piece of vinyl, the size of the printing surface (1 x 0.14m) and stick it onto the printing surface.
3. Power on the DC4sx and load the media. Print out a rectangle full width and height, consisting out of two colors app 20% coverage.
4. Remove the media from the DC4sx and turn off the power.
5. Carefully remove the vinyl from the printing surface.

This test has been done with 3M cast white vinyl. Do not attempt to use any other vinyl to clean the printing surface. The reaction of the adhesive on the printing surface might damage it. Do not leave the vinyl on the printing surface longer than is necessary for this test.

5.1.7 Cleaning the OptiTrac™ sensor

The sensor will collect dust. Therefore, the small hole in the sensor should be cleaned regularly with a cotton-tipped swab.

➔ Cleaning the OptiTrac™ sensor system:

1. Locate the hole in the sensor holder at the right side of the printer carriage.
2. Clean by wiping it out with cotton swabs.

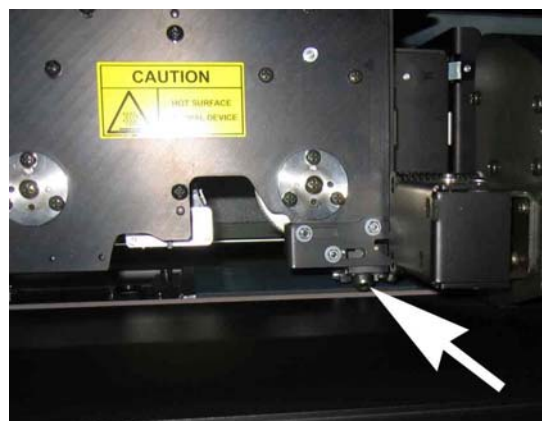

FIG 5-5
CLEANING OPOS SENSOR

5.2 OPERATING VOLTAGE

CAUTION: Before changing the fuse, make sure that the cutter is completely disconnected from its power source.

CAUTION: For continued protection against risk of fire, replace only with the same type and rating of fuse: T4.0A, 250V SCHURTER SPT OR EQUIVALENT.

The power entry module detects the line voltage and switches automatically between 110V and 230V.

The fuse is at the back, next to the power inlet.

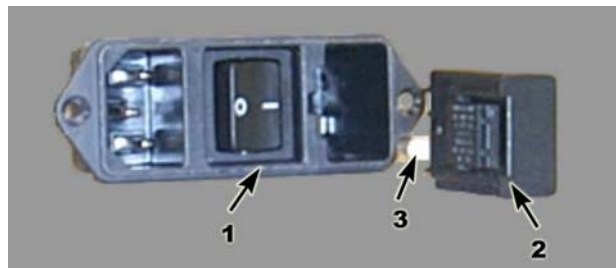

FIG 5-6
POWER ENTRY MODULE

1. Power entry module
2. Fuse holder
3. Fuse

6.1 Introduction

The installation/manual CD contains following program's/plug in's:

1. Summa Printer Control.
2. Spot color palette for Corel and Illustrator.
3. Summa Color Control (optional – dongle required).
4. WinPlot.
5. Plug in for Corel and Illustrator for Summa Color Control and WinPlot.
6. ICC profiles.

When the installation CD is inserted in the computer, then it starts normally automatically. If not, launch the routine manually from the “Run” command line in the Windows Start menu. Type “D:\autostart.exe” (where D is the CD-ROM drive).

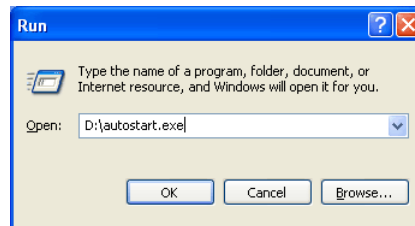

After that the start-up screen appears.

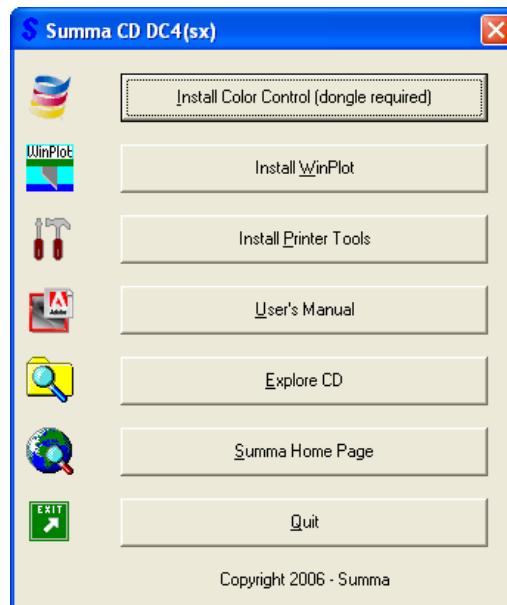

FIG 6-1
INSTALLATION OF SOFTWARE

6.1.1 Installing Summa Color Control

Color Control is a RIP it can import eps files and then send the data to the printer. It accepts both print and contour-cut data. Color Control requires a hardware key (also called a dongle).

Click on the button to install.

During the installation the language can be chosen:

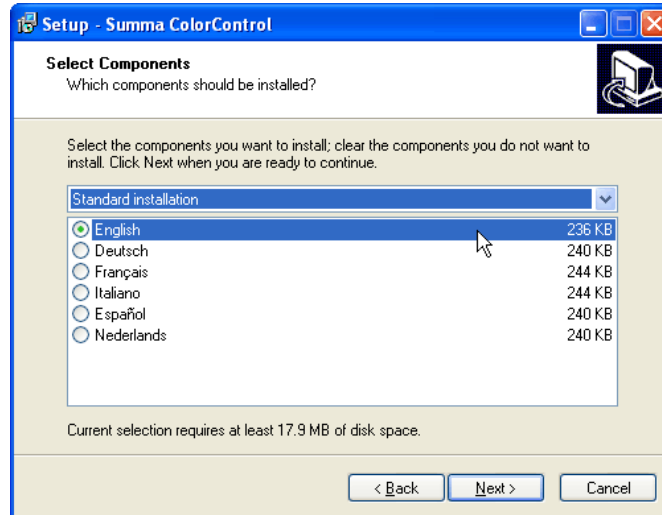

FIG 6-2
LANGUAGE SELECTION OF SCC

The last option is whether to install the driver for the dongle or not. The installation program remembers whether the driver has been installed or not. If not then this option is automatically set to on, other wise it is set to off.

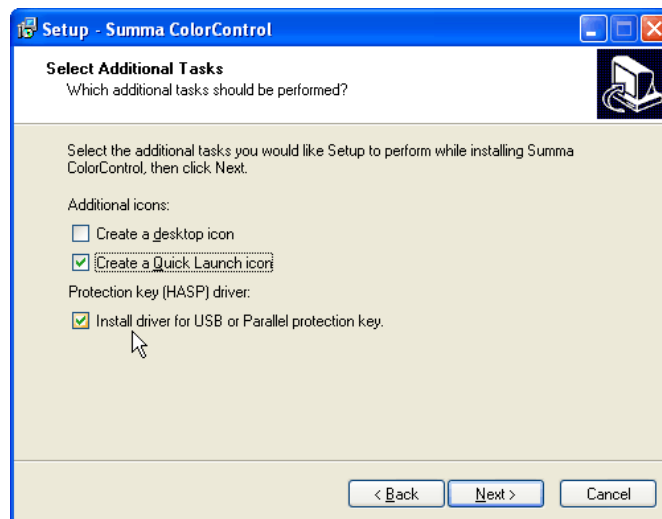

FIG 6-3
HASP DRIVER INSTALLATION

The driver is a third party driver from the company Aladdin. Follow the instruction on screen. The installation may take a while.

Wait until the program shows it has finished the installation of the driver. Then install the dongle and wait again until Windows reports that the dongle is ready to use.

Then Color Control can be started.

It is not recommended to change the options during the installation.

See section 0 for explanation of the options of Color Control.

6.1.2 Installing WinPlot

WinPlot is a cutter driver. It accepts eps and ai files with cut data. It can send then the data to the DC4sx.

The DC4sx is not made to use as a cutter. Reason for that is the supply mechanism. It is internally switches off during cutting (to avoid that the supply roll unrolls out off itself because of the constant movement of the vinyl during cutting). So when the DC4sx is used for cutting only, the media has to be loaded as a 'sheet'. It is recommended to use WinPlot only when using OPOS contour cutting (see section 3.1.1.2).

To install WinPlot, just click on the button and follow instructions on screen. It is not recommended to change the options. Restarting computer after installing WinPlot is not necessary if no other processes were running during installation.

6.1.3 Installing printer tools

Following useful tools can be installed with this program:

1. Plug-in for CorelDraw (from version 12 on) and Adobe Illustrator (from version CS on) for WinPlot and Color Control. The plug-in for Corel install an extra toolbar. Clicking on an icon in this toolbar automatically exports the current drawing into the program indicated in the toolbar. The plug-in for Illustrator creates an extra menu under the 'file menu' called summa. From there the current design can be exported into Color Control or WinPlot.
2. Palette for spot color definitions in ColorDraw (from revision 10 on) and Adobe Illustrator (from version 10 on). The palette includes also the special color 'contour'. With this spot color the print and cut data can e separated. All objects in the design which have as color 'contour' will not be printed by Color Control, but cut out after first printing the other data.
3. ICC profiles. The use of ICC profiles is explained in a separate document that can be found on the installation CD.
4. Summa Printer Control. The Summa Printer Control Program for MS Windows is a software utility to optimize the overall printing and cutting capabilities of the DC4sx.

Click on the button to install.

The individual printer tools can be installed directly after installation of the printer tool program, or afterwards.

This installation just puts all the tools on your hard disk, ready for installation
To install later, just click on start -> All Programs -> Summa -> Summa Printer Tools.
It is recommended to install directly after installations of the printer tool program.
To install immediately leave 'Launch Summa Printer Tools' checked.

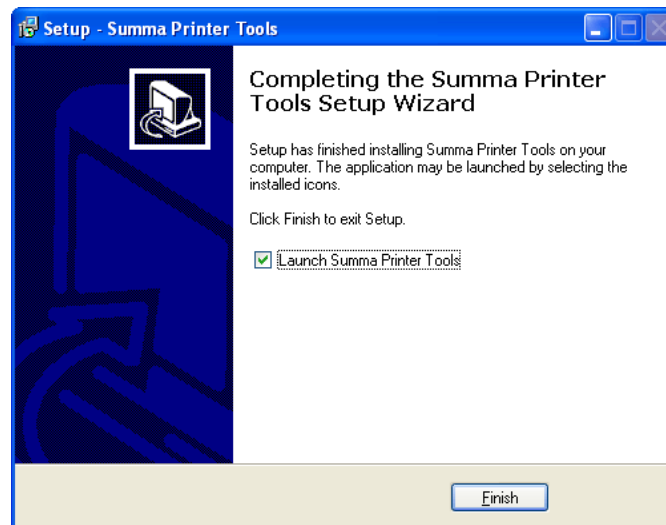

FIG 6-4
INSTALLATION OF PRINTER TOOLS

Clicking the 'Full installation' button installs all printer tools.
The tools can be installed individually also.
By clicking on the tab's all the utilities can be installed separately.

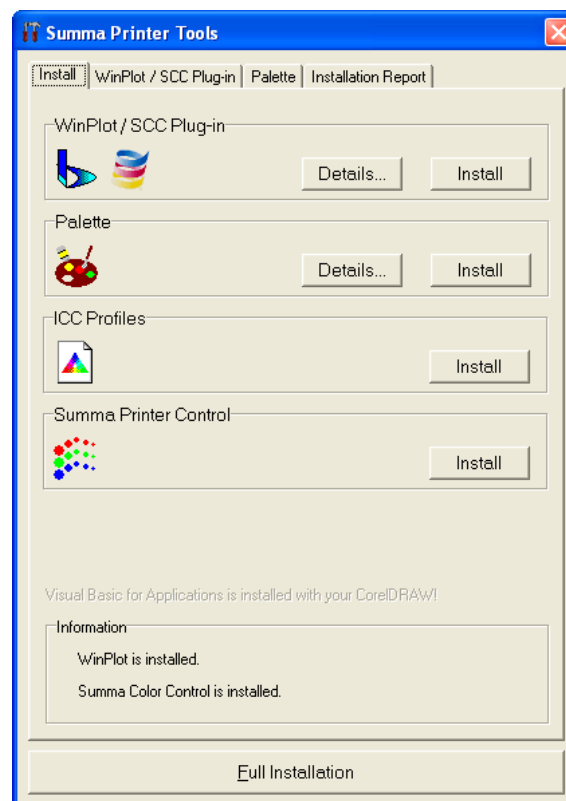

FIG 6-5
INSTALLATION OF SEPARATE PRINTER TOOLS

6.2 Summa Printer Control Menus

The Summa Printer Control program basically has the same functions as the control panel. It is up to the user to decide which way he will work most efficiently. The users who will work with the Summa Printer Control program will notice that it is a very powerful and practical tool.

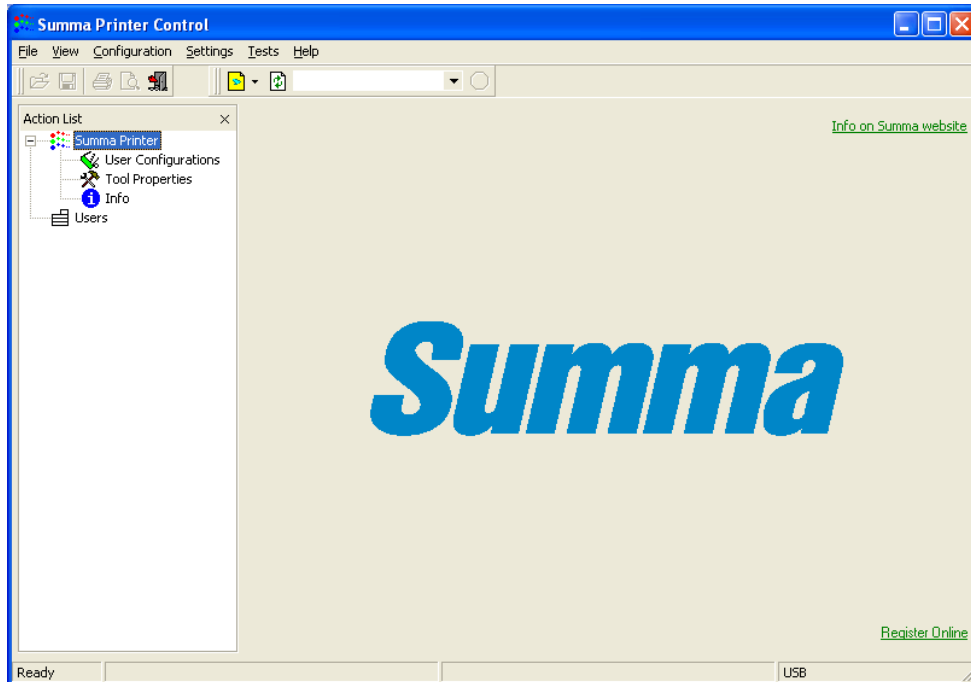
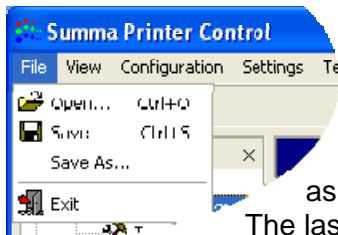

FIG 6-6
SUMMA PRINTER CONTROL START SCREEN

6.2.1 File menu



With the file menu, configuration settings can be saved on the computer and loaded from its hard disk. The options are only highlighted if a connection between the DC4sx and the computer has been established. This can be useful as back-up or extra users.

The last item in this menu will exit the program.

6.2.2 View menu

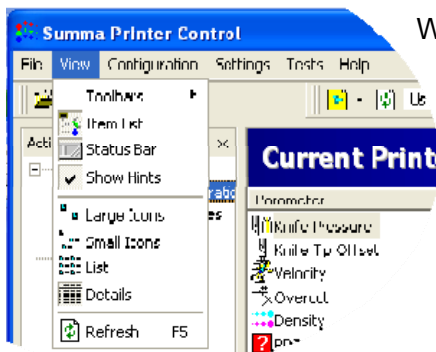

With the view menu, the appearance of the program can be changed. Some options are only highlighted if a connection between the DC4sx and the computer has been established.

6.2.3 Configuration menu

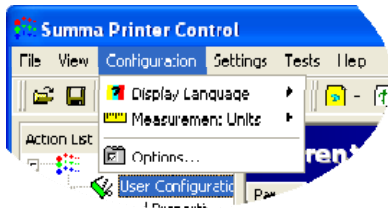

With the configuration menu, the language and units of measurement, which Summa Printer control uses, can be changed. With the option menu more or less parameters can be made visible.

6.2.4 Settings menu

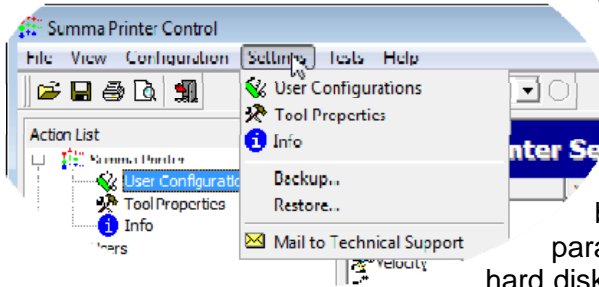

The settings menu can be used to display certain DC4sx parameters on your computer. These parameters can be changed and saved on the computer hard disk, and also in DC4sx memory. This menu can also be used to make a backup of all the parameters or restore a backup (from the hard disk of the computer). The settings can also

be mailed to Summa.

6.2.5 Tests menu

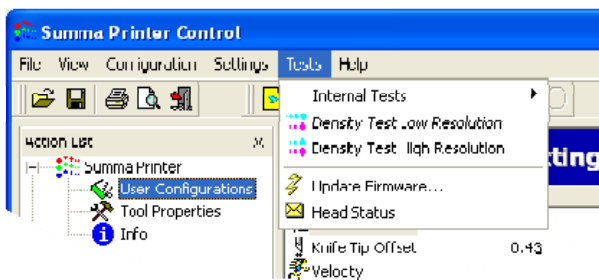

The test menu is used for starting internal DC4sx tests, updating the DC4sx firmware and to check how many prints the printhead has printed. The internal tests are the same as on the hard disk (if the option is installed).

6.2.6 Action list

With the action list, or the setting menu, parameters settings of the DC4sx can be displayed on the computer.

6.2.7 Configuration settings

Below is a screen capture of the parameters that can be changed using Summa Printer Control (option 'show hidden parameters' is set to on). When a parameter is changed, then the parameter and the value are displayed in bold on the computer and the cancel and apply button are highlighted. Click on 'apply' to send the new value to the DC4sx.

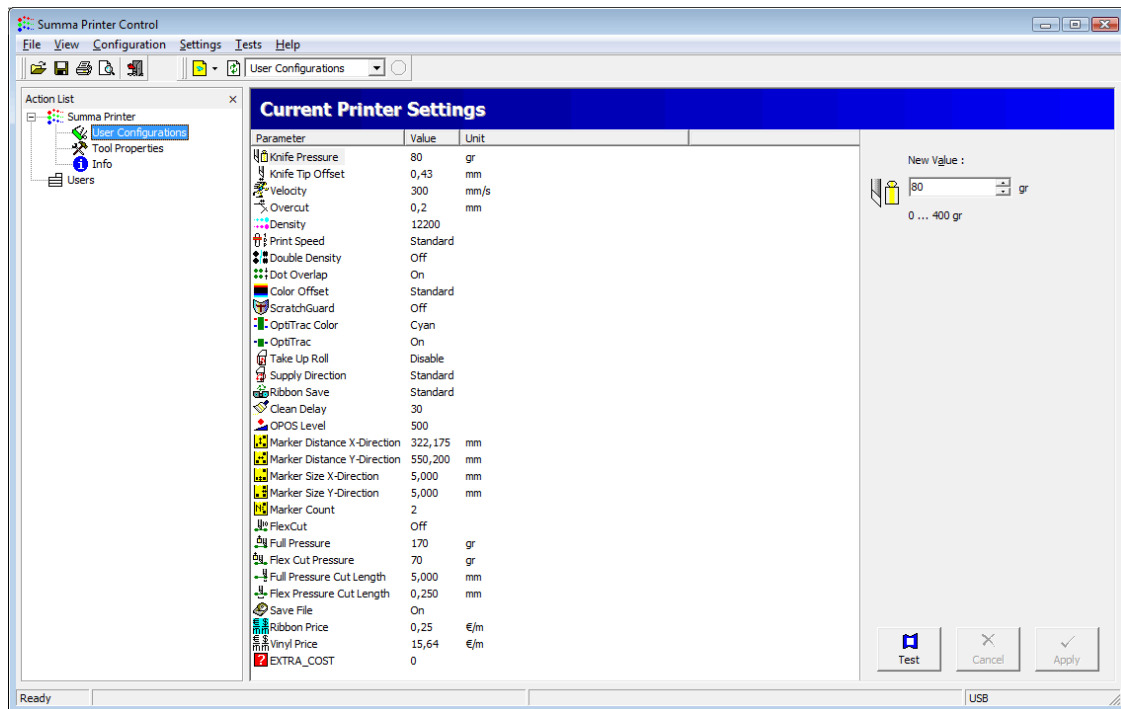

FIG 6-7
CONFIGURATION SETTINGS

6.2.8 Tool properties

The tool properties are typical parameters used for the contour cutting knife blade. The coil settings are for service use only.

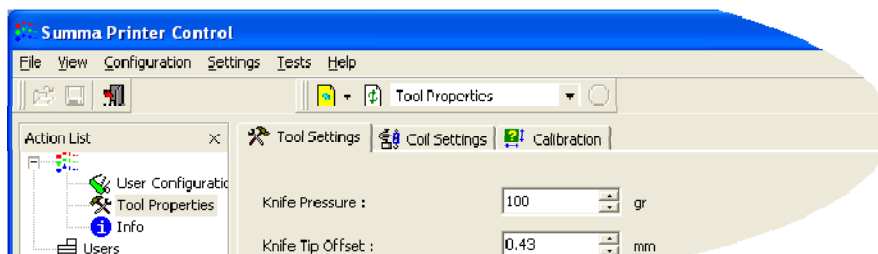

FIG 6-8
TOOL PROPERTIES

6.2.9 Info

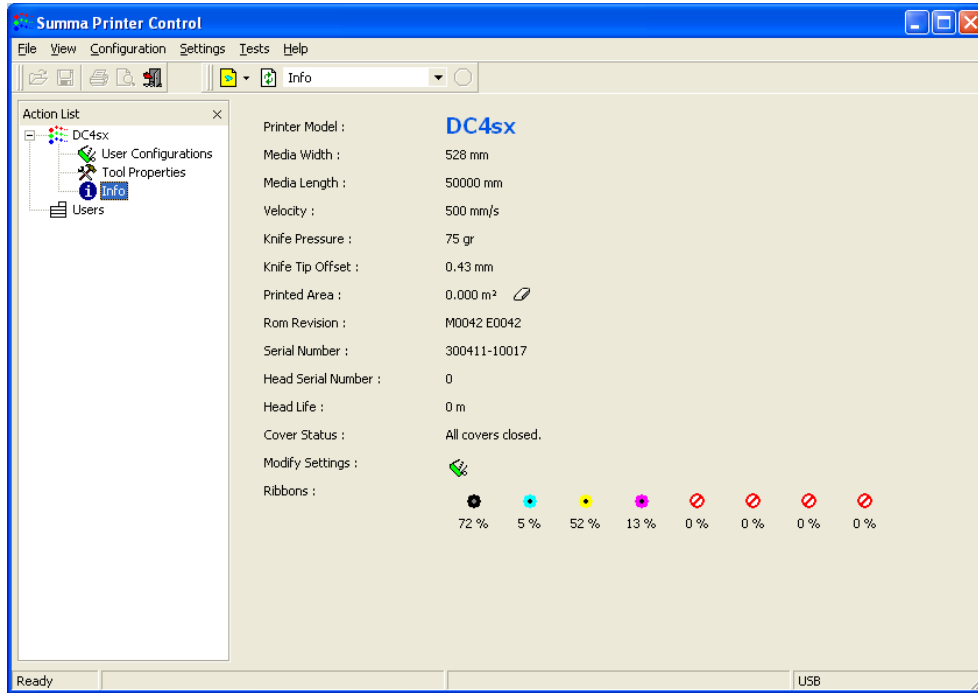

FIG 6-9
INFO

Info gives the operator the most important parameters at a glance. The printed media area can be set to zero with the eraser tool right next to it. The screenshot is made when info is clicked while holding the shift key pressed.

6.2.10 Users

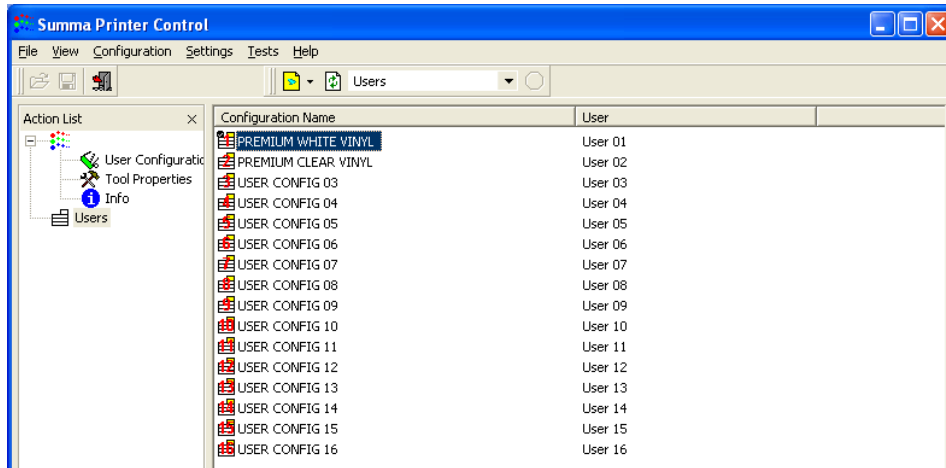

FIG 6-10
USER CONFIGURATIONS

With this the operator can change the active user and also change the user name. By default user 01 and user 02 are factory set for premium cast white and premium clear vinyl. Click right on the user to show the parameters of that user, set active or change the name of that user.

6.2.11 Tool bars

Summa Printer Control has two toolbars. The first toolbar is just a copy of the File menu.

The second tool bar is a mix of much used commands.



With this button, printer- and test files can be sent to the printer. This can also be used to upgrade the printer.



The refresh button re-establishes communication with the printer and refreshes the parameter currently shown on screen.

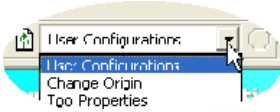

This is a copy of the action list which can be seen at the left side.



This icon is only highlighted while Summa Printer Control is communicating with the cutter. Clicking on it interrupts the connection.

6.3 Summa Color Control (SCC) configuration

The software is optional. The program is included on the installation CD, but it works only with a dongle.

6.3.1 ColorControl Preferences

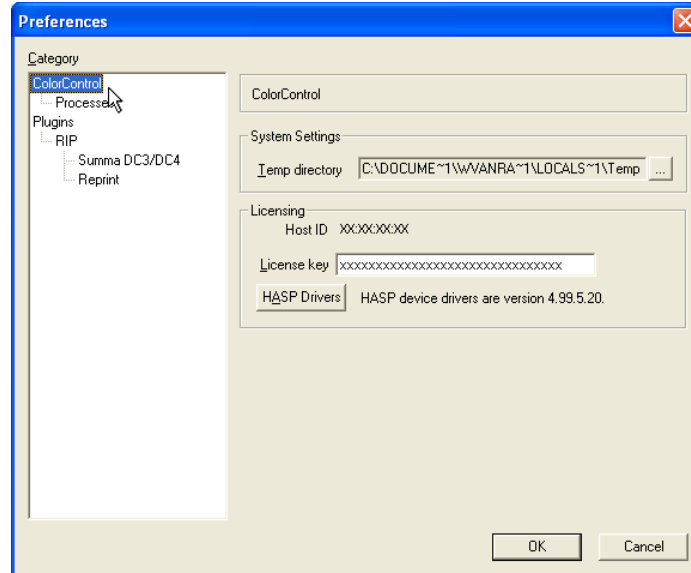

FIG 6-11
COLORCONTROL PREFERENCES

1. Temp directory: Indicates where SCC writes temporary files during processing. SCC uses the default MS Windows temp directory.
2. License key: In this box the dongle license number appears. If this box is blank, then either the HASP drivers are not installed or the dongle is missing, defective or the printer is turned off. **The printer must always be turned on before launching Summa Color Control.**

6.3.2 Process preferences

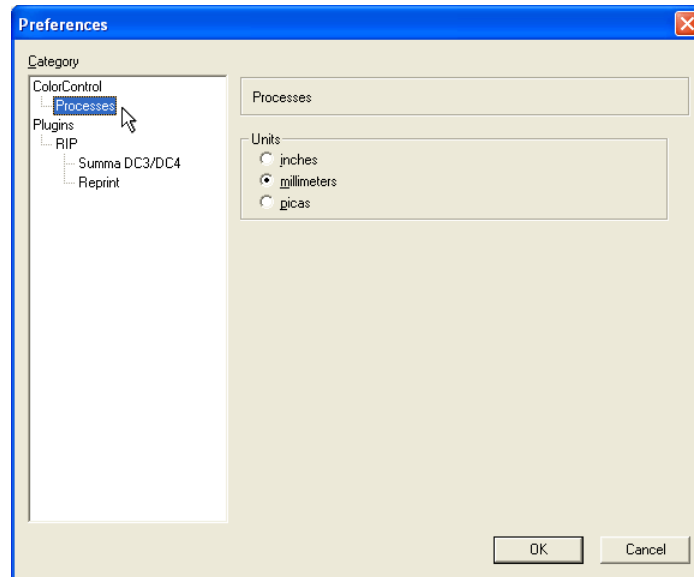

FIG 6-12
PROCESS PREFERENCES

Units: sets the units of measurement for pixel resolution, page size and rulers within the preview menu.

6.3.3 RIP preferences

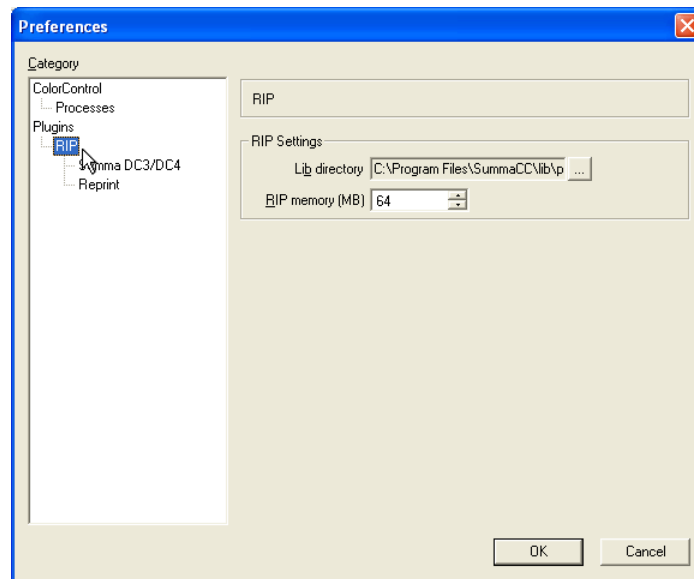

FIG 6-13
RIP PREFERENCES

1. Lib directory: where SCC's library files reside. The default is "C:\Program Files\SummaCC\lib\psrip3". If during an installation the files are stored elsewhere, then change this setting appropriately. If the settings are incorrect, SCC will give a fatal error when ripping.
2. RIP memory (MB): the amount of RAM SCC uses while processing files. The default is the minimum 64MB. The maximum memory used by SCC is 256MB.

6.3.4 DC4sx preferences

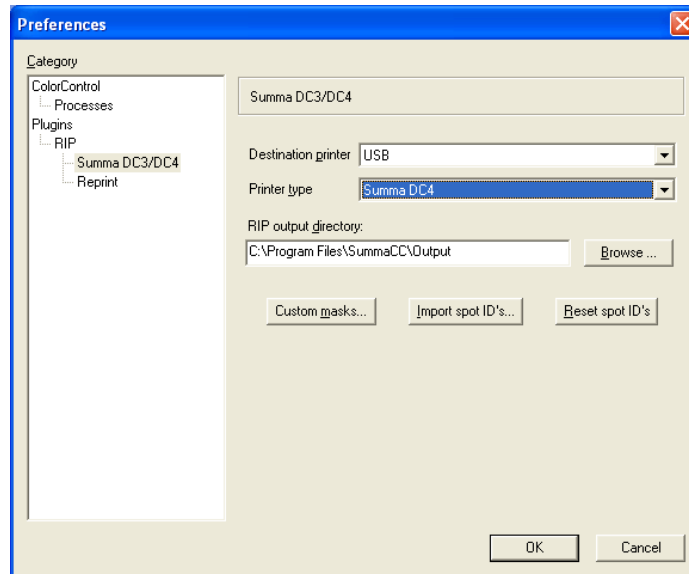

FIG 6-14
PREFERENCES

1. Destination printer: select the interface port, most commonly used is the USB port.
2. Check if printer type is set to Summa DC4sx. This is important for maximum printing width and tile size.
3. RIP output directory: specify the directory where ripped files will be stored. Please BE VERY CAREFUL and watch this directory as large ripped files can accumulate and fill your computers hard disk quickly.
4. Custom masks: import custom-made masks for the Vision Print feature. It is recommended to use bitmaps with a height that is a multiple of 16 pixels.
5. Import Spot ID's: allows new spot color ID's to be created and imported when a new spot color is released.
6. Reset Spot ID's: resets spot ID's to factory default.

6.3.5 Reprint preferences

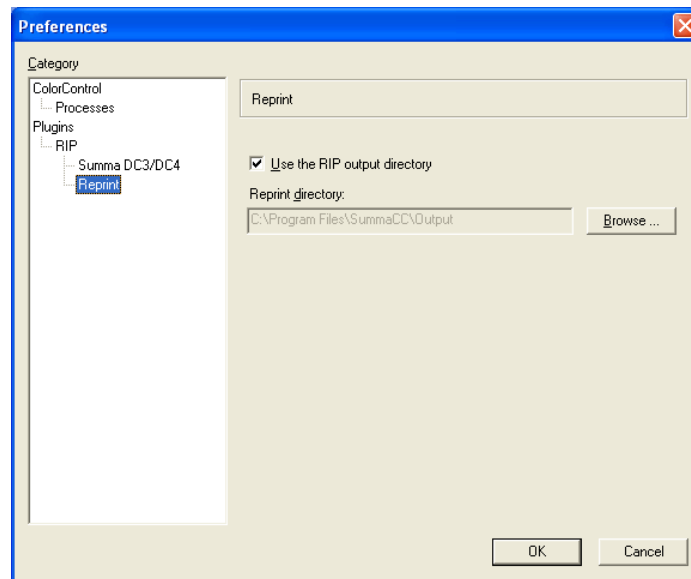

FIG 6-15
REPRINT PREFERENCES

Reprint directory: select to use the RIP output directory or choose another location to store ripped files.

6.3.6 How to rip and print

To begin, enter the **File** menu and click on **Print to Summa DC3/DC4...**. In the subsequent dialog boxes, browse to the file that needs to be printed and click on the **Open** button. The print dialog box will appear, there are 5 tabs.

6.3.7 General tab

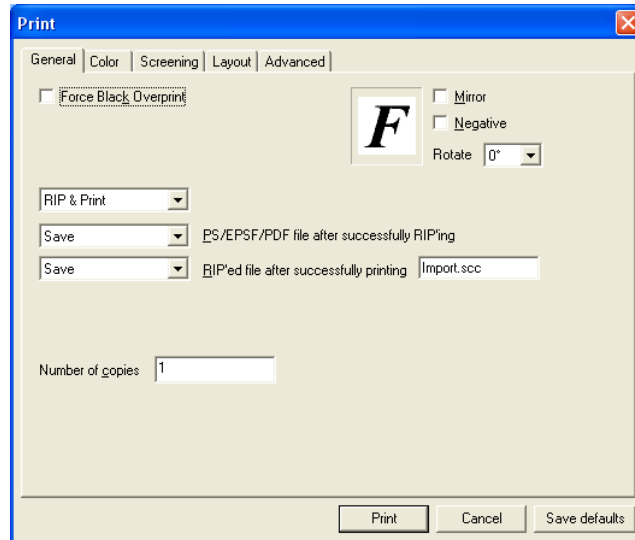

FIG 6-16
GENERAL TAB

1. **Force Black Overprint:** overprints all black elements, which help to prevent small black text from dropping out the background color.



FORCE BLACK OVERPRINT ON



FORCE BLACK OVERPRINT OFF

2. **Mirror:** reverses the image, which is useful for some backlit and window graphic applications.
3. **Negative:** creates a negative image, which is useful for screen-printing applications.
4. **RIP & Print:** select which operation to perform.
5. **Rotate:** rotates an image 90°, 180° or 270°.
6. **Save PS/EPS/PDF file after successfully ripping:** Select whether to save or delete the file that has just been ripped.
7. **Save Ripped file after printing:** Select whether to save or delete the ripped file, after printing. The location of the ripped files can be set in the preference menu. If this option is set to on, then this subdirectory has to be checked regularly in order not to flood the hard disk.
8. **Number of copies:** specify the number of copies to print.

6.3.8 Color Tab

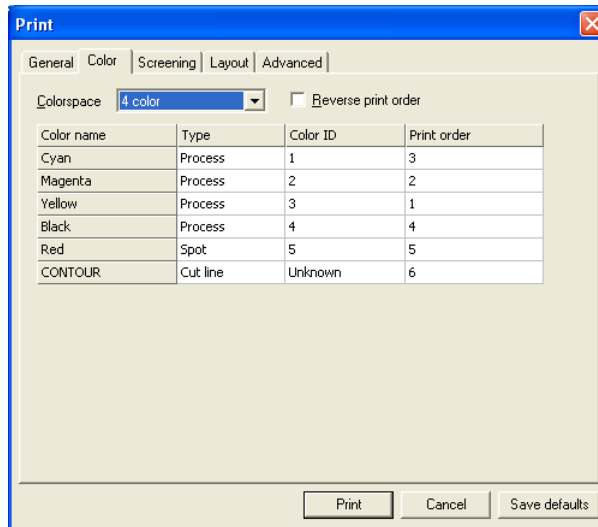
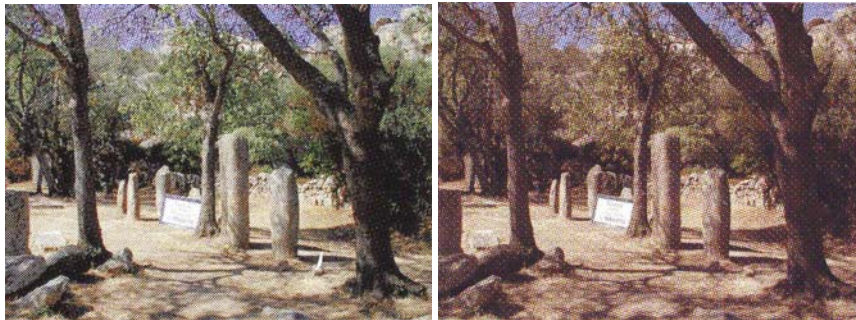

FIG 6-17
COLOR TAB

1. Colorspace: select 3 color (CMY), 4 color (CMYK), Monochrome (Grey scale) or spot color only. Printing in 4 colors is chosen to deepen shadows and to provide a true black. Printing in 3 colors reduces the cost of the output. (See fig below – only visible in color)



PRINTED CMYK

PRINTED CMY

2. Reverse print order: reverses the print order. This option is used for reverse backlit applications to preserve the lightest color being printed first. Choosing this option also has as a result that the masking colors are printed last. The best print order is always YMCK.
3. Type: CMYK information in the file will default to "Process". If spot color information is assigned in the design software, then they will appear here as "Spot". The spot colors can be changed to "As process" if the spot color ribbons are not available. The spot color "CONTOUR" is an exception. SCC will cut out any information in spot color "CONTOUR". There can only be one 'contour color'. Also the spot color "FLEXCUT" is an exception. SCC will cut out any information in spot color "FLEXCUT" in FlexCut (see section 3.2). There can only be one 'FLEXCUT color'
4. Cassette Number: refers to the ribbon ID number. Numbers are assigned automatically if SCC recognizes the color name.
5. Print order: specify the order in which the color planes will be printed. Ideally, process colors always print in YMCK order, lightest color first.

6.3.9 Screening tab

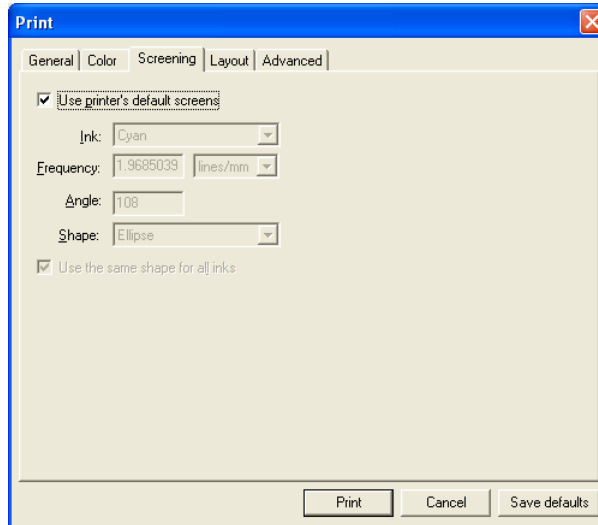

FIG 6-18
SCREENING TAB

1. **Use printer's default screens:** the frequency, angle and dot shape that are specified in the EPS file will be used while ripping and printing. If this box is unchecked, then those parameters can be changed for different effects.
2. **Ink:** Use the same shape and frequency for all colors; otherwise unexpected patterns will appear in the design.
3. **Frequency:** The frequency is the 'line frequency' (lpmm or lpi). This parameter determines the size of the cell in which dots are put together to create the colors. Do not confuse this term 'dots per mm' (dpmm or dpi). Dpmm is the resolution of the printer. The head of a DC4sx has a fixed resolution of 12 dpmm (304 dpi). The number of shades depends on the relation between dpmm and lpmm (lpi and dpi). The formula is $(dpmm/lpmm)^2$ or $(dpi/lpi)^2$. It is recommended to use only frequencies between 0.8 and 2 lines /mm (20 to 50 lines/inch). Below is an example of printing out a gradient from 100 to 0% black with respectively 1, 1.55, 2.35 lpmm (25, 40 and 60 lpi) and a smooth gradient

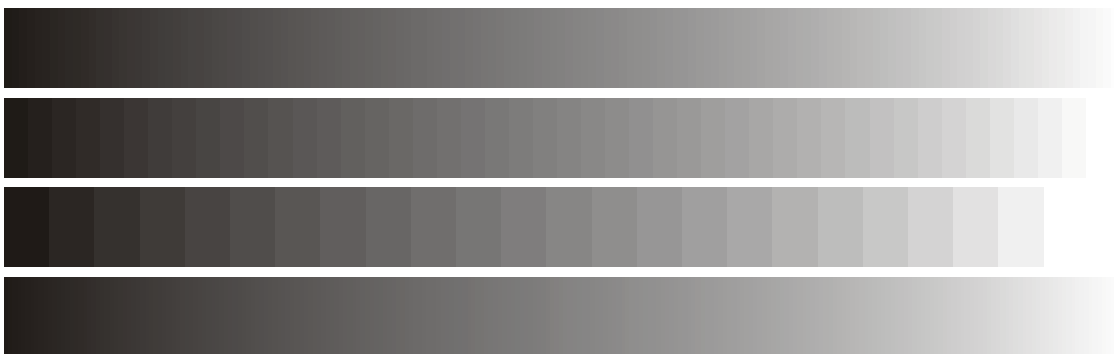

FIG 6-19
DIFFERENCE BETWEEN LINE FREQUENCIES

4. Angle: To get various shades to reproduce an image, the RIP uses a process called screening. Screening breaks an image down into series of dots. Each screen is set to a certain angle. Thus creating intersecting rows that form a pattern as dot shapes, know as rosettes. The default angles are carefully chosen in order to minimize the 'moiré' effect. Changing those angles will normally not reduce moiré. Moiré usually emerges in scanned pictures; add noise in the picture to solve the moiré problem.

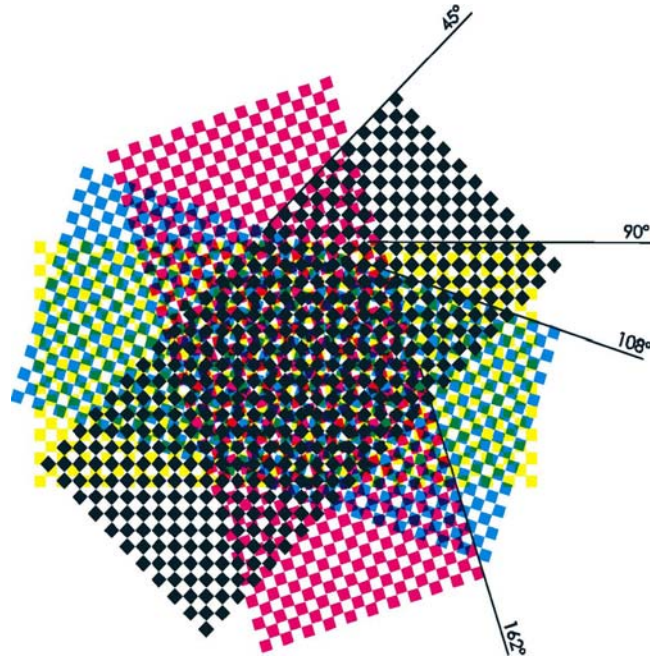
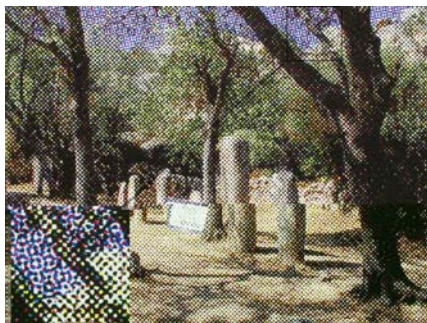
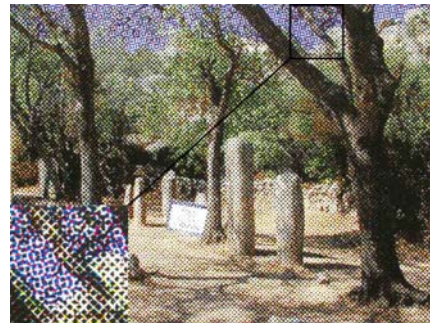

FIG 6-20
SCREEN ANGLES

5. Shape: Here the shape of those dots can be chosen. Below is an illustration of the various available dot shapes.



ROUND



SQUARE

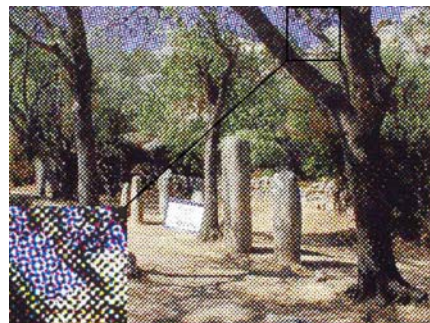

DIAMOND

CROSS

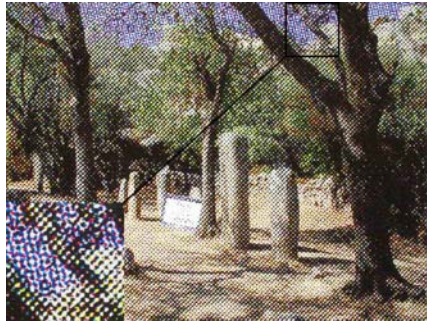

ELLIPSE

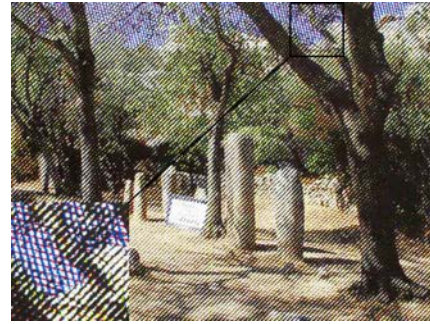

LINE

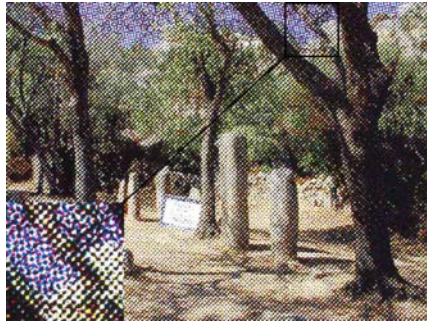

RHOMBOID

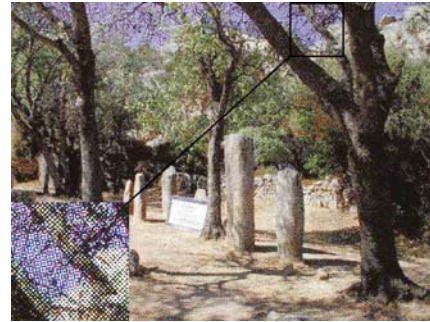

DOUBLE DOT

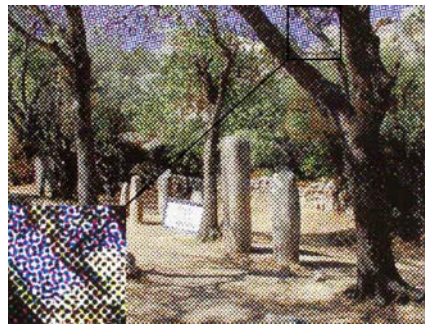

SINGLE DOT

The shape, shown in the enlarged section, is a result of the combination of postscript pattern and angle and frequency.

Ellipse is the recommended default shape. Rhomboid, Double Dot and other shapes are can be chosen for special effects, but are not generally recommended. Summa cannot guarantee print quality using any shape other than Ellipse.

Tips:

For difficult colors, use Rhomboid 0.8 to 1.1 lines /mm (20 to 30 lines/inch)

For more steps in gradients, use Double Dot 1 line/mm (25 lines/inch)

A standard setting for mid to large designs is Rhomboid 2 lines/mm (50 lines/inch)

Do Not Use Double Dot with line frequencies higher than 1.3 lines/mm (35 lines/inch), and only for relatively small images (smaller the one band width). Severe banding can occur when improperly using the Double Dot shape.

6.3.10 Layout tab

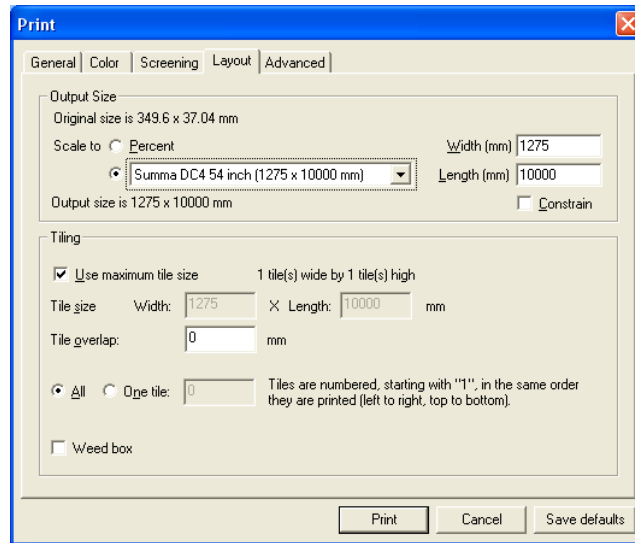

FIG 6-21
LAYOUT TAB

1. Output size: scale the EPS file to any size or specify a page size. To determine the exact output size, click first on Summa DC3/DC4 (1275 x 10000 mm), then change to the desired size in the width or height box. Enable Constrain box to constrain the proportions during resizing.
2. Tiling: If the image needs to be tiled, specify the tile size and the amount of overlap between each tile. Check the Use maximum tile size box to use the maximum print width. There is also the option to print out each tile separately. If the weed box option is chosen, then the DC4sx cuts a border around the print out.

6.3.11 Advanced tab

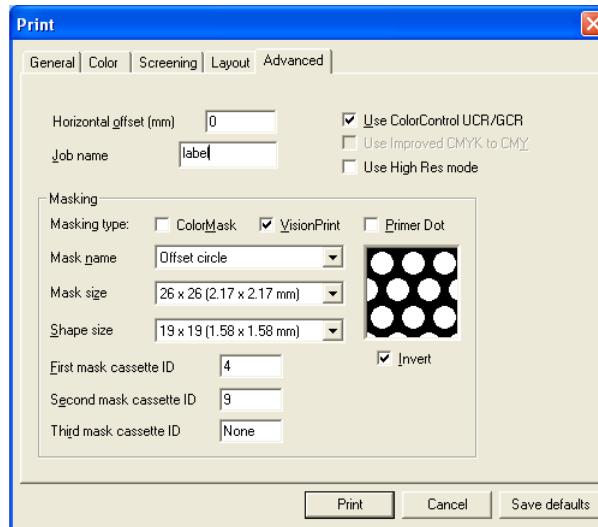
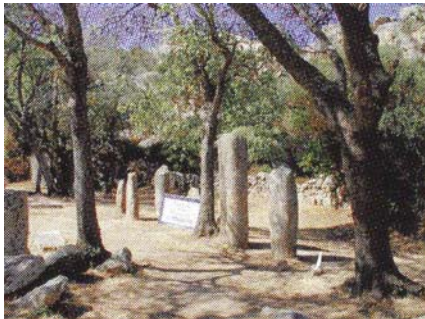
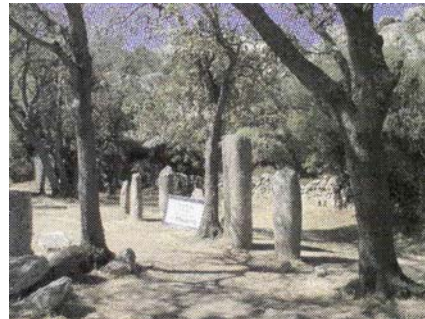

FIG 6-22
ADVANCED TAB

1. Horizontal offset: specify the offset from the origin of a normal printout.
2. Job name (optional): specify the name the printer will use in the printer's queue.
3. Use ColorControl UCR/GCR: a process that determines the amount of black ink used to replace CMY in areas where those three inks overlap. (Under Color Removal and Grey Component Replacement). It is highlighted only when working in 4-color mode. (See fig below – only visible in color)



PRINTED NO UCR/GCR



PRINTED WITH UCR/GCR

4. Use Improved CMYK to CMY: a choice between two different embedded color profile tables. Used when CMY images appear too dark.

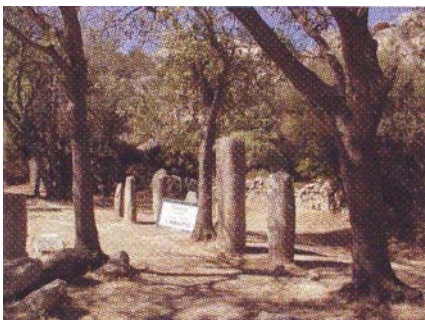

IMPROVED CMYK TO CMY

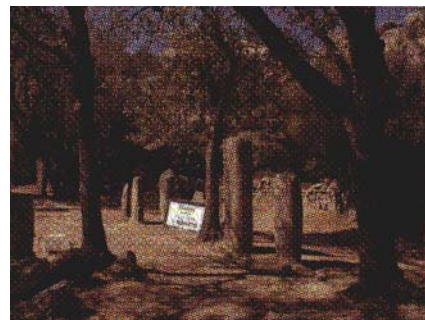

NO IMPROVED CMYK TO CMY

5. Use High resolution mode is an option to print in high resolution. When this mode is used, then the DC4 prints with a resolution of 304x608 dpi which results in higher color contrast and sharper images.
6. Masking is an option to print color layers underneath other colors. Commonly used for printing on clear vinyl. Choose between ColorMask (complete coverage), Primer dot (printed dot on dot, or pixel on pixel) and VisionPrint (perforated hole patterns). The patterns in VisionPrint can be chosen with 'Mask name'. The size of the pattern can be changed with 'Mask size' and 'Shape size'. The small window next to the shape option, displays the pattern that will be printed out. The black area indicates area to be printed and the white area indicates what will not be printed. There is a choice of one, two or three masking layers. Fill in the cassettes numbers for selected layers as needed.

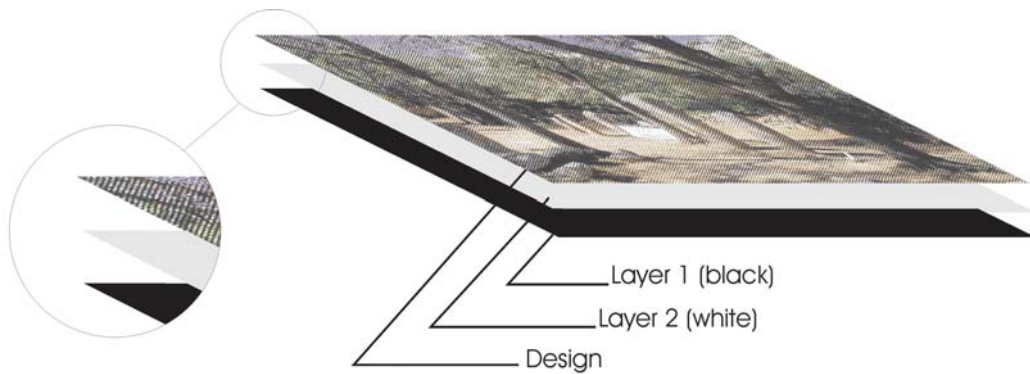

FIG 6-23
MASKING

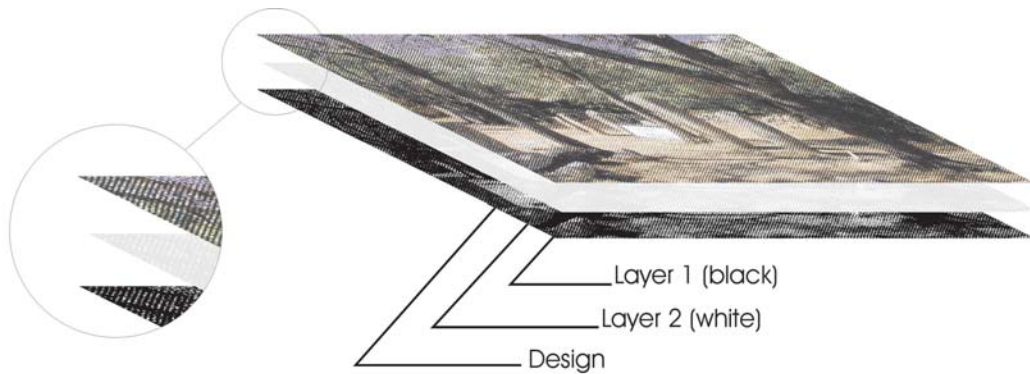

FIG 6-24
PRIMER DOT

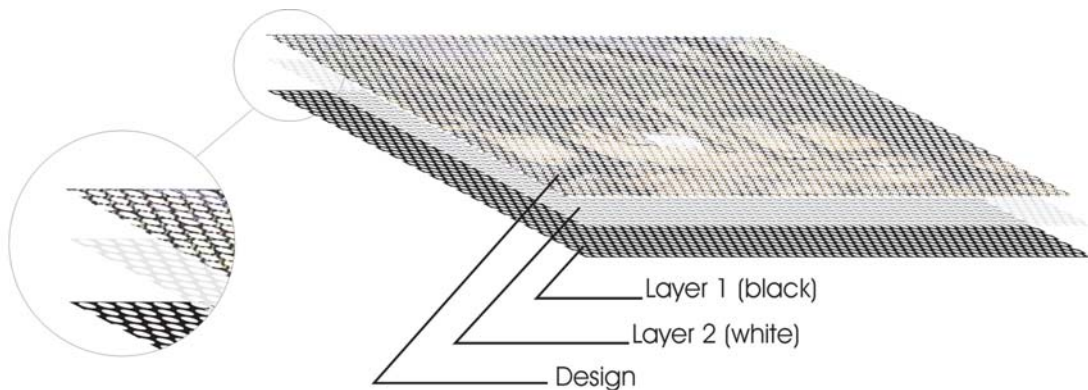





FIG 6-25
VISION PRINT

6.3.12 How to rip,View and print

Follow next procedure to RIP, View and print.

Enter the  menu and click on .

In the print dialogue box choose .

Set the rest of the printing preferences as explained in previous section.

Click on .

Enter the  menu and click on .

The ripped file can be checked, it can not be altered any more.

Spot colors do not show in the preview.

Click on the  icon.

Choose the file with the same name as on the preview window.

Then print out the file.



7.1 Features List

7.1.1 Hardware

- OptiPrint™ media cleaner (Optional on DC4sx)
- Powered roll feed system with media flanges
- Powered roll up system with media flanges (Optional on DC4sx)
- Baskets (Optional on DC4sx)
- Rear and Front Media sensor
- Hard-Disk (2 GB job storage space) (Optional on DC4sx)

7.1.2 Interface

- 8-key control panel.
- 4x20-character liquid crystal display.
- English Display language.
- Metric or English units.

7.1.3 Functionality

- 16 user configurations.
- Auto Alignment system.
- Up to eight colors/job
- OptiTrac
- Ribbon save
 - Right side of band
 - OptiTrac colors : Mirror silver and Gold
- Cutting:
 - Concatenation and curve smoothing to obtain better cut quality.
 - OptiCut drag-movement optimization.
 - Overcut for easy weeding.
- Multiple reprint feature (up to 999).
- Flash Eproms

7.1.4 Software

- Summa Color Control / SCC (Optional on DC4sx)
 - Postscript Level 3 compatible RIP
 - Import EPS, PDF of PS files
 - Scaling, rotating, mirroring, inversing
 - Panelling
 - Colormask and Primerdot
 - Contour Cutting
 - Spotcolor support
- WinPlot
 - “Bridge” program to cut artwork created in other programs.
 - Windows 98, 2000 & XP
 - Connection by USB, serial, parallel or any printer port installed on your operating system
 - Import of simple AI, EPS and DXF files
 - Plug-in for CorelDraw 11,12 and X3 and Adobe Illustrator CS and CS2
 - Nesting, panelling, weeding box and cut by color possibilities
 - Integration of OPOS
- Summa Printer Control
 - Program to control printer parameters.
 - Utility to upgrade firmware
 - Possibility to store user configurations on hard disk
 - Windows 98, 2000 & XP